



**NIBP Controller
Owner's Guide**



This document was, as far as possible, accurate at the time of release. However, changes may have been made to the software and hardware it describes since then. ADInstruments Pty Ltd reserves the right to alter specifications as required. Late-breaking information may be supplied separately.

Trademarks of ADInstruments

PowerLab[®], LabChart[®], LabTutor[®], LabAuthor[®] and MacLab[®] are registered trademarks of ADInstruments Pty Ltd. The names of specific recording units, such as PowerLab 8/30, are trademarks of ADInstruments Pty Ltd. LabTutor Server, Chart and Scope (application programs) and LabTutor Online are trademarks of ADInstruments Pty Ltd.

Other Trademarks

Apple, Mac and Macintosh are registered trademarks of Apple Computer, Inc.

Windows, Windows 7 and Windows Vista are either registered trademarks or trademarks of Microsoft Corporation

All other trademarks are the property of their respective owners.

Product: ML125 NIBP Controller

Document Number: U-ML125-OG-003C

Part Number: 4375

Copyright © April 2014 ADInstruments Pty Ltd.
Unit 13, 22 Lexington Drive, Bella Vista, NSW 2153, Australia

All rights reserved. No part of this document may be reproduced by any means without the prior written permission of ADInstruments Pty Ltd.

Web: www.adinstruments.com
Technical Support: support.au@adinstruments.com
Documentation: documentation@adinstruments.com

ADInstruments Pty Ltd. ISO 9001:2008 Certified Quality Management System

Reg. No. 1053

Contents

Safety Notes	5
1 Overview	13
Checking the NIBP Controller	14
The Front Panel	14
The Power Indicator	14
Status Indicator	14
Cuff Pressure Connection	14
Pulse Input Connector	15
Filter Switch (Pulse Range).	15
Start/Stop Button	15
The Back Panel.	15
I2C Input and Output Sockets	15
Pressure Signal Output	16
Pulse Signal Output	16
Max mmHg Switch	16
Gain Adjust	16
Trigger In Connector	16
Trigger Out Connector	16
2 Using the Controller	17
Connecting the NIBP Controller.	18
Connecting to PowerLab	18
Optional Trigger Controls	18
Connecting to Other ADInstruments Front-ends	19
Power-up Test	19
Recording with the NIBP Controller	19
Connecting Pulse Transducers	20
Indirect Blood Pressure Measurements in Small Animals using Tail Cuffs	21
Background Information	21
Protocol Development Guidelines.	22

A Technical Details **25**

How it Works	26
Circuit Principles	26
Pump Control.	27
Pressure and Pulse Monitoring	27
The Pulse Input Connector	28

B Specifications **29**

Cycle Operation.	29
Manual Start/Stop Input	29
Remote Trigger Input	30
Trigger Output	30
Pressure Output (Cuff Pressure)	30
Pulse Input	30
Operating Requirements.	30
Physical Configuration.	30

Index **31**



Safety Notes

Statement of Intended Use

All products manufactured by ADInstruments are intended for use in teaching and research applications and environments only. ADInstruments products are NOT intended to be used as medical devices or in medical environments. That is, no product supplied by ADInstruments is intended to be used to diagnose, treat or monitor a subject. Furthermore no product is intended for the prevention, curing or alleviation of disease, injury or handicap.

Where a product meets IEC 60601-1 it is under the principle that:

- it is a more rigorous standard than other standards that could be chosen, and
- it provides a high safety level for subjects and operators.

The choice to meet IEC 60601-1 is in no way to be interpreted to mean that a product:

- is a medical device,
- may be interpreted as a medical device, or
- is safe to be used as a medical device.

Safety Symbols

Devices manufactured by ADInstruments that are designed for direct connection to humans are tested to IEC 601-1:1998 (including amendments 1 and 2) and 60601-1-2, and carry one or more of the safety symbols below. These symbols appear next to those inputs and output connectors that can be directly connected to human subjects.



BF symbol: Body-protected equipment

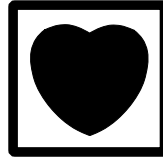

CF symbol: Cardiac-protected equipment



Warning symbol: 'see documentation'

The three symbols are:

- BF (body protected) symbol. This means that the input connectors are suitable for connection to humans provided there is no direct electrical connection to the heart.
- CF (cardiac protected) symbol. This means that the input connectors are suitable for connection to human subjects even when there is direct electrical connection to the heart.
- Warning symbol. The exclamation mark inside a triangle means that the supplied documentation must be consulted for operating, cautionary or safety information before using the device.

Further information is available on request.

Bio Amp Safety Instructions

The Bio Amp inputs displaying any of the safety symbols are electrically isolated from the mains supply in order to prevent current flow that may otherwise result in injury to the subject. Several points must be observed for safe operation of the Bio Amp:

-
- All Bio Amp front-ends (except for the ML138 Octal Bio Amp) and PowerLab units with a built-in Bio Amp are supplied with a 3-lead or 5-lead Bio Amp subject cable and lead wire system. The ML138 Octal Bio Amp is supplied with unshielded lead wires (1.8 m). Bio Amps are only safe for human connection if used with the supplied subject cable and lead wires.
 - All Bio Amp front-ends and PowerLab units with a built-in Bio Amp are not defibrillator-protected. Using the Bio Amp to record signals during defibrillator discharges may damage the input stages of the amplifiers. This may result in a safety hazard.
 - Never use damaged Bio Amp cables or leads. Damaged cables and leads must always be replaced before any connection to humans is made.

Isolated Stimulator Safety Instructions

The Isolated Stimulator outputs of a front-end signal conditioner or PowerLab with a built-in isolated stimulator are electrically isolated. However, they can produce pulses of up to 100 V at up to 20 mA. Injury can still occur from careless use of these devices. Several points must be observed for safe operation of the Isolated Stimulator:

- The Isolated Stimulator output must only be used with the supplied bar stimulus electrode.
- The Isolated Stimulator output must not be used with individual (physically separate) stimulating electrodes.
- Stimulation must not be applied across the chest or head.
- Do not hold one electrode in each hand.
- Always use a suitable electrode cream or gel and proper skin preparation to ensure a low-impedance electrode contact. Using electrodes without electrode cream can result in burns to the skin or discomfort for the subject.
- Subjects with implantable or external cardiac pacemakers, a cardiac condition, or a history of epileptic episodes must not be subject to electrical stimulation.
- Always commence stimulation at the lowest current setting and slowly increase the current.
- Stop stimulation if the subject experiences pain or discomfort.
- Do not use faulty cables, or those that have exhibited intermittent faults.
- Do not attempt to measure or record the Isolated Stimulator waveform while connected to a subject using a PowerLab input or any other piece of

equipment that does not carry the appropriate safety symbol (see Safety Symbols above).

Always check the status indicator on the front panel. It will always flash green each time the stimulator delivers a current pulse. A yellow flash indicates an 'out-of-compliance' (OOC) condition that may be due to the electrode contact drying up. Always ensure that there is good electrode contact at all times. Electrodes that are left on a subject for some time need to be checked for dry contacts. An electrode impedance meter can be used for this task.

- Always be alert for any adverse physiological effects in the subject. At the first sign of a problem, stimulation must be stopped, either from the software or by flicking down the safety switch on the front panel of any built-in Isolated Stimulator or the ML180 Stimulus Isolator.
- The ML180 Stimulus Isolator is supplied with a special transformer plug pack. The plug pack complies with medical safety requirements. Therefore, under no circumstances should any other transformer be used with the Stimulus Isolator. For a replacement transformer plug pack please contact your nearest ADInstruments representative.

General Safety Instructions

To achieve the optimal degree of subject and operator safety, consideration should be given to the following guidelines when setting up a PowerLab system either as stand-alone equipment or when using PowerLab equipment in conjunction with other equipment. Failure to do so may compromise the inherent safety measures designed into PowerLab equipment. The following guidelines are based on principles outlined in the international safety standard IEC60601-1-1: *General requirements for safety - Collateral standard: Safety requirements for medical systems*. Reference to this standard is required when setting up a system for human connection.

PowerLab systems (and many other devices) require the connection of a personal computer for operation. This personal computer should be certified as complying with IEC60950 and should be located outside a 1.8 m radius from the subject (so that the subject cannot touch it while connected to the system). Within this 1.8 m radius, only equipment complying with IEC60601-1 should be present. Connecting a system in this way obviates the provision of additional safety measures and the measurement of leakage currents.

Accompanying documents for each piece of equipment in the system should be thoroughly examined prior to connection of the system.

While it is not possible to cover all arrangements of equipment in a system, some general guidelines for safe use of the equipment are presented below:

- Any electrical equipment which is located within the SUBJECT AREA should be approved to IEC60601-1.
- Only connect those parts of equipment that are marked as an APPLIED PART to the subject. APPLIED PARTS may be recognized by the BF or CF symbols which appear in the Safety Symbols section of these Safety Notes.
- Only CF-rated APPLIED PARTS must be used for direct cardiac connection.
- Never connect parts which are marked as an APPLIED PART to those which are not marked as APPLIED PARTS.
- Do not touch the subject to which the PowerLab (or its peripherals) is connected at the same time as making contact with parts of the PowerLab (or its peripherals) that are not intended for contact to the subject.
- Cleaning and sterilization of equipment should be performed in accordance with manufacturer's instructions. The isolation barrier may be compromised if manufacturer's cleaning instructions are not followed.
- The ambient environment (such as the temperature and relative humidity) of the system should be kept within the manufacturer's specified range or the isolation barrier may be compromised.
- The entry of liquids into equipment may also compromise the isolation barrier. If spillage occurs, the manufacturer of the affected equipment should be contacted before using the equipment.

- Many electrical systems (particularly those in metal enclosures) depend upon the presence of a protective earth for electrical safety. This is generally provided from the power outlet through a power cord, but may also be supplied as a dedicated safety earth conductor. Power cords should never be modified so as to remove the earth connection. The integrity of the protective earth connection between each piece of equipment and the protective earth should be verified regularly by qualified personnel.
- Avoid using multiple portable socket-outlets (such as power boards) where possible as they provide an inherently less safe environment with respect to electrical hazards. Individual connection of each piece of equipment to fixed mains socket-outlets is the preferred means of connection.

If multiple portable socket outlets are used, they are subject to the following constraints:

- They shall not be placed on the floor.
- Additional multiple portable socket outlets or extension cords shall not be connected to the system.
- They shall only be used for supplying power to equipment which is intended to form part of the system.

Cleaning and Sterilization

ADInstruments products may be wiped down with a lint free cloth moistened with industrial methylated spirit. Refer to the manufacturer's guidelines or the Data Card supplied with transducers and accessories for specific cleaning and sterilizing instructions.

Preventative Inspection and Maintenance

PowerLab systems and ADInstruments front-ends are all maintenance-free and do not require periodic calibration or adjustment to ensure safe operation. Internal diagnostic software performs system checks during power up and will report errors if a significant problem is found. There is no need to open the instrument for inspection or maintenance, and doing so within the warranty period will void the warranty.

Your PowerLab system can be periodically checked for basic safety by using an appropriate safety testing device. Tests such as earth leakage, earth bond, insulation resistance, subject leakage and auxiliary currents and power cable integrity can all be performed on the PowerLab system without having to remove the covers. Follow the instructions for the testing device if performing such tests.

If the PowerLab system is found not to comply with such testing you should contact your PowerLab representative to arrange for the equipment to be checked and serviced. Do not attempt to service the device yourself.

Environment

Electronic components are susceptible to corrosive substances and atmospheres, and must be kept away from laboratory chemicals.

Storage Conditions

- Temperature in the range 0–40 °C
- Non-condensing humidity in the range 0–95%.

Operating Conditions

- Temperature in the range 5–35 °C
- Non-condensing humidity in the range 0–90%.

Disposal

- Forward to recycling center or return to manufacturer.

Overview

The ADInstruments ML125 NIBP (Non-Invasive Blood Pressure) Controller performs non-invasive blood pressure measurement on rats and mice using specialised tail cuffs.

This Owner's Guide covers the features of the NIBP Controller and its operation with your ADInstruments PowerLab[®] and LabChart software.

Checking the NIBP Controller

The unit passes quality control inspection before leaving the factory. However, there is a small chance that damage may occur in transit.

1. Check there are no obvious signs of damage to the outside casing.
2. Check there are no obvious signs of internal damage (like rattling).

If you find a problem, please contact your ADInstruments distributor immediately.

The Front Panel

Figure 1-1
The front panel of the
NIBP Controller

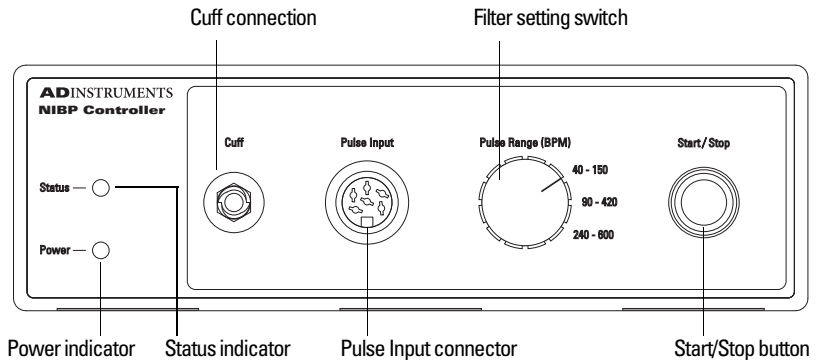

The Power Indicator

The Power indicator will light when the unit is on. If not, check that the unit is properly connected to the PowerLab, and that the PowerLab is properly connected to a power socket and is switched on.

Status Indicator

The Status indicator light can be in one of three states:

- Off: Idle, no measurement in progress
- Green: Inflating cuff
- Orange: Deflating cuff

Cuff Pressure Connection

This port has a luer lock fitting and is where the tail cuff is attached. The NIBP system can be purchased with either a cuff suitable for rats or a cuff

suitable for mice. The pressure is measured by way of an internal pressure transducer. Output is from the 'Pressure Output'.

Pulse Input Connector

The pulse transducer is attached here. The signal is amplified and filtered inside the NIBP Controller. Output is from the 'Pulse Output'.

Filter Switch (Pulse Range)

This three position switch adjusts the filtering of the pulse signal. Details of the frequency response are in Appendix B. For mice, use the 240–600 BPM setting. For rats, 90–420 BPM is usually appropriate.

Start/Stop Button

The NIBP Controller measurement cycle is started by pushing the Start/Stop button. This begins an inflation and deflation cycle. To stop the measurement cycle (during either inflation or deflation) push the button again. This will stop the cycle and immediately deflate the cuff.

The Back Panel

Figure 1-2
The back panel of the
NIBP Controller

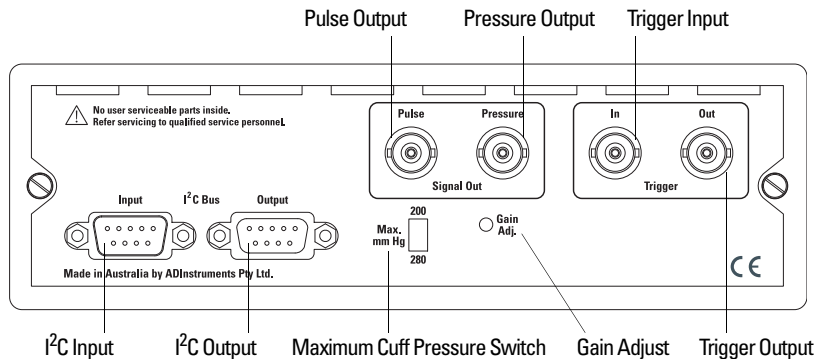

I²C Input and Output Sockets

The NIBP Controller is designed to receive power and control signals from an ADInstruments PowerLab. These are supplied by an 'I²C Bus' (a 'bus' is simply information-transmission circuitry such as cables and connectors). These I²C sockets allow many front-ends to be used independently with one PowerLab. The I²C Input socket of the NIBP Controller connects to the I²C Output of the PowerLab or a previous front-end in the system. The I²C

Output socket of the NIBP Controller allows connection of further ADInstruments front-ends to the system, in series (the input of the next connects to the output of the previous).

Pressure Signal Output

Connect this output to a PowerLab input channel to record pressure. This signal is proportional to the cuff pressure and is precalibrated to produce 1 V per 300 mmHg. By using Units Conversion in LabChart you can easily display the cuff pressure in mmHg (or similar units).

Pulse Signal Output

Connect this output to a PowerLab input channel to record the pulse. This pulse signal is used to determine the points at which the pressure signal will be read to calculate systolic pressures.

Max mmHg Switch

This switch sets the maximum cuff inflation pressure, which will occur immediately before deflation takes place. Two settings are available: 200 and 280 mmHg.

Gain Adjust

This control allows an increase or decrease in the amplification of the signal to suit the type of pulse transducer being used. It will have been factory set, and you should not find it necessary to make further adjustment. The adjustment of this control is described in Chapter 2.

Trigger In Connector

This trigger connector provides a means to start and stop the NIBP measuring cycle from an external device that is providing a TTL compatible signal. This input can be connected to the analog output of a PowerLab so that the LabChart recording software can send a trigger signal (use a 3–5 V pulse when setting up triggering in LabChart) to start a measurement cycle.

Trigger Out Connector

This connector provides a signal that can be used by the LabChart software to make data recording take place only during the measurement cycle. This is useful if you are performing multiple measurement cycles at, say, 30 minute intervals, and do not want to record the unwanted signals between cycles. This output is connected to the External Trigger input of a PowerLab. The signal is TTL compatible (zero or 5 V) and indicates 5 V when a measurement cycle is taking place.

2

Using the Controller

This chapter guides you through connecting your NIBP Controller to your PowerLab and performing a power-up test to make sure there are no problems. This chapter also covers setting up the NIBP Controller in a typical system, and calibrating the pressure signals.

IMPORTANT: Always make sure that the PowerLab is turned off before you connect or disconnect the NIBP Controller. Failure to do so may damage the PowerLab and/or the NIBP Controller.

Connecting the NIBP Controller

Connecting to PowerLab

To connect the NIBP Controller to your PowerLab system, first make sure that the PowerLab is turned off. Connect your PowerLab to the computer and power, as detailed in your PowerLab Owner's Guide. Note: the PowerLab should remain off while making connections to it as hardware may be damaged if the PowerLab is on.

Connect the I²C Output of the PowerLab to the I²C Input of the NIBP Controller. Additional ADInstruments front-ends may be connected to the system by connecting to the I²C Output of the NIBP Controller.

Figure 2-1
Rear view of a NIBP Controller on a PowerLab, showing the connections that have been made

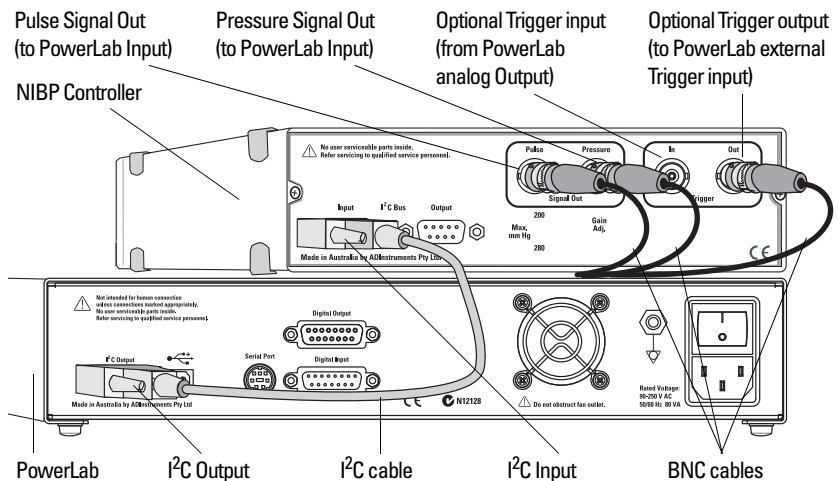

With BNC cables, connect the Pulse Signal Out socket on the back of the NIBP Controller to one of the analog inputs on the front of the PowerLab and connect the Pressure Signal Out socket on the back of the NIBP Controller to another of the analog inputs of the PowerLab. Both these connections must be made to determine blood pressure.

Optional Trigger Controls

The NIBP Controller has two control signal sockets on the rear panel. The Trigger In is used to start an NIBP measurement cycle from an external source such, as the PowerLab. By connecting this input to either the analog output or digital output (if supported) of your PowerLab you can get the LabChart or Scope software to automatically start the NIBP Controller at preset times.

The Trigger Out is an output from the NIBP Controller that produces a 5 V signal during the measurement cycle. This can be connected to the Trigger input of the PowerLab to control the duration of recording, or to start LabChart or Scope recording when the cycle is started.

Both these controls are optional and allow much more automation of the recording process, if desired or required.

Connecting to Other ADInstruments Front-ends

The NIBP Controller is designed to be used with other ADInstruments front-ends. The NIBP Controller can be used anywhere in the series of I²C connections, as long as there are enough analog inputs on your PowerLab to support the required number of signals of the front-ends.

Power-up Test

Follow these steps to perform a power-up test of the NIBP Controller:

1. Connect your NIBP Controller to your PowerLab, as above.
2. Turn on your PowerLab. The Power indicator should light.
3. The NIBP Controller Power indicator should also light and the Status indicator should be off.

Recording with the NIBP Controller

Follow these steps to begin recording with the NIBP Controller:

1. Once the NIBP Controller is connected to your PowerLab as described above and as shown in Figure 2–1, connect the pressure cuff to the Cuff connection on the front of the NIBP Controller, and connect the pulse transducer to the Pulse Input connector. Connect the pressure cuff and pulse transducer to the mouse or rat. A typical experimental setup is shown in Figure 2–2.
2. Perform a power-up test of the NIBP Controller, described above.
3. Select the appropriate filter setting using the Filter Setting switch on the front panel of the NIBP Controller, and set your maximum cuff inflation pressure, by using the switch on the rear panel.
4. Open LabChart on your computer and set it up for the two channels attached to the NIBP Controller; one channel for the pulse signal, and the other for pressure. The pulse channel range should be set to 50 mV. The pressure channel range should be set to 1 V, and Units Conversion should be set up to give 0 V = 0 mmHg and 1 V = 300 mmHg.

Figure 2–2
The NIBP Controller and PowerLab set up for use with tail cuff, pulse transducer and animal restraint cage

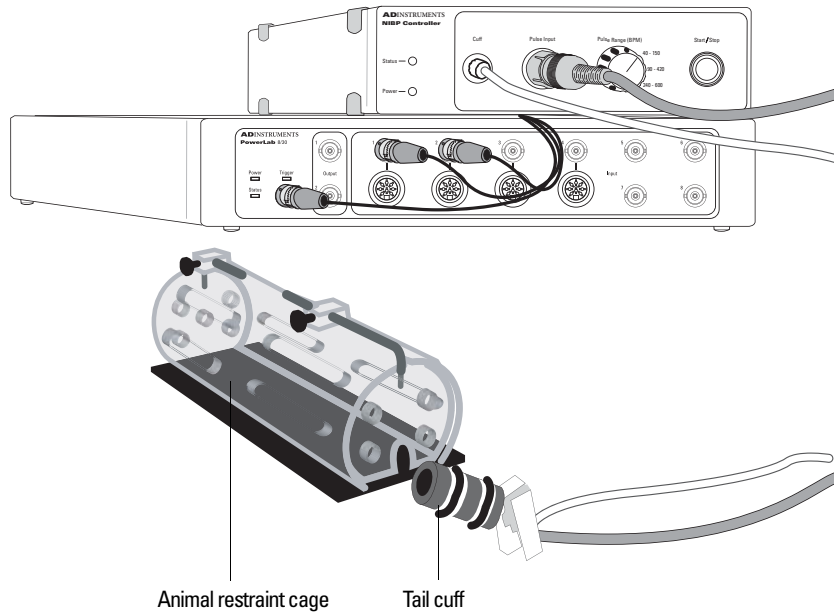

5. Click the Start button in LabChart to begin recording.
6. Push the Start/Stop button on the front of the NIBP Controller to begin a measurement cycle. The pump should start and the cuff should inflate. Observe that the pressure waveform climbs up to the preset maximum cuff pressure. At some point in the inflation cycle you should see the pulse signal start to decrease in amplitude as the cuff starts to occlude the blood flow.

When the maximum cuff pressure is reached, the pump will stop and the pressure will begin to drop. The pressure will drop until it reaches about 40 mmHg at which point a valve is opened to release the remaining air quickly. As the pressure drops the pulse signal will start to increase again. Typical data is shown in Figure 2–3.

Connecting Pulse Transducers

The Pulse Input connector (Figure 1–1) on the front panel is a 6 pin DIN type connector allowing attachment of the pulse transducer in the MLT125M (mice) or MLT125R (rats) Pulse Transducer and Pressure Cuff assemblies. Your NIBP system will have been purchased with one of these assemblies. They are also available separately if you require a replacement, or wish to study both mice and rats.

Figure 2-3
Typical recording using
LabChart showing the
pulse and pressure signals

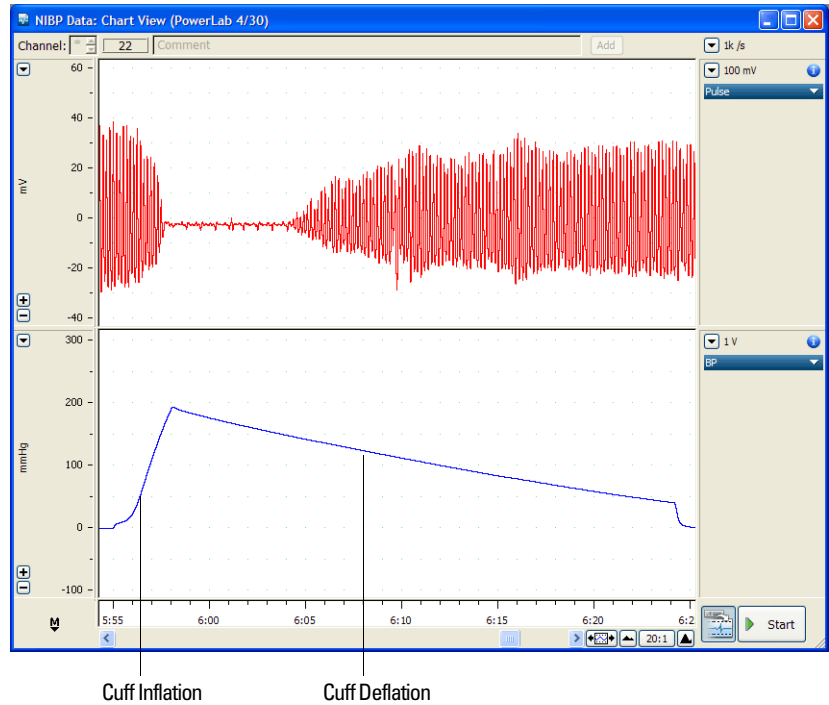

Indirect Blood Pressure Measurements in Small Animals using Tail Cuffs

Background Information

This technique has been used routinely for the non-invasive measurement of blood pressure in rats, and more recently in mice. The technique provides a good estimate of actual systolic pressure. Although non-invasive, the protocol details related to the technique (warming, handling, restraint and so on) will inevitably have some effect on the actual blood pressure. The technique is useful as a comparative measurement, particularly when carried out on a well-habituated animal.

The major advantage of the PowerLab approach to this technique is that it provides an accurate and permanent record of the pulsatile data recorded from the tail during the measurement cycle. It therefore makes it possible for scientists to develop protocols and detection algorithms that correlate with their experiment. We do not offer a method of estimating diastolic pressure, because to date very little published data is available on the efficacy of such methods.

Users are presented with all the information that is typically recorded by NIBP systems and can implement their own algorithms.

The following guidelines are provided to assist in the development of protocols and reliable algorithms for the non-invasive measurement of blood pressure in small animals.

Protocol Development Guidelines

1. **Training:** Most animals require some training, habituation to the protocol, and careful handling to produce repeatable results; rats are more readily trained than mice. Two to three training sessions may be necessary to acclimatize the animals. Even when the animal has been trained it may take a few minutes before a distinct pulse is measurable on the tail.
2. **Restraint cages:** These are necessary for conscious animals. Ensure that Perspex restraint cages are selected to fit the animal comfortably. Place the animal in the Perspex cylinder restraint cage and adjust the depth to restrict forward and backward movement within the tube. The tube should prevent the animal from turning around.
3. **External stimuli:** Sudden motion and sounds should be restricted as much as possible, since they cause animal movement. It sometimes helps to cover the restraint cage with a cloth to reduce the impact of external stimuli.
4. **Temperature maintenance:** Warming rats and mice improves blood circulation in the tail and the signal to noise ratio in the recording. Typically animals should be preheated to 28–30 °C and maintained at that temperature during the test.
5. **Tail cuff:** The tail cuff is used to occlude blood flow in the tail and thereby interrupt the pulse that is measurable in the caudal artery. The tail cuff is positioned at the proximal end of the tail.
6. **Pulse transducer positioning:** The active site of the pulse transducer should be located on the ventral surface of the tail, directly below the caudal artery. The transducer is positioned directly following the tail cuff. Maximum sensitivity is achieved when the artery is positioned above the most sensitive position on the transducer. Movement from this position can reduce the amplitude of the measured pulses.
7. **Mechanical vibrations:** The transducer used to make the pulse measurements is very sensitive and subject to vibrations. Ensure that mechanical vibrations from other laboratory devices do not affect the transducer.

8. Measured signals: The basic signals recorded by the ML125 NIBP system are the cuff pressure and the caudal artery pulse.

Cuff pressure is an accurate high level signal with noise of less than ± 0.1 mmHg and absolute error of less than ± 2 mmHg (after calibration).

This data is used in association with the reappearance of the caudal artery pulse to determine the systolic pressure.

The caudal artery pulse is a low level pulse requiring significant amplification—this is particularly true of mice. The signal is therefore mixed with noise, and subject to movement and respiratory artifacts. The signal amplitude may alter significantly as the animal moves and repositions the transducer in relation to the caudal artery.

A significant feature of the caudal artery pulse is its frequency. For a conscious rat this is typically in the range 200–500 BPM. For a given set of circumstances this frequency is relatively constant. The user should be aware of this frequency, as it will be useful in later analysis.

A sampling rate in the range of 100 – 1000 samples per second will be adequate for pulse measurements.

Movement and respiratory artefacts in tail pulse measurements are particularly disruptive because they often occur at times coincident with actual measurements. However, it should be noted that the technique is dependent not on the amplitude of the pulse, but rather its onset.

9. Systolic measurement: Systolic measurement can normally be made with relative ease. Systolic blood pressure (SBP) occurs when the cuff pressure corresponds to the restoration of the first caudal artery pulse. The presence of noise will inevitably introduce some uncertainty in this estimate, but typical SBP measurements will be within 5% of direct blood pressure measurements. Repeat each measurement five to six times to ensure reproducible results are being obtained.

Although direct observation of the pulse is usually sufficient to determine the systolic blood pressure point, alternative methods of detecting the onset of the pulse (by performing certain calculations in LabChart on the pulse signal) are also available, and may in some circumstances be used effectively:

- a. RMS measurement of pulse: This can be done using the RMS function in the Data Pad and can be useful in providing a direct measurement of pulse energy. An averaging period of about 500 ms to 1 second is useful.
- b. Cyclic height: The Cyclic Measurements ‘Height’ function allows an

offline measurement of cycle height. This is particularly useful when the pulse amplitude is modulated by a respiratory artefact.

- c. Ratemeter: The Cyclic Measurements 'Rate' function can be set up to accurately measure and display the tail pulse rate, and to directly indicate the position of the systolic blood pressure point (as shown in Figure 2-4).

Figure 2-4
Measurement of tail pulse rate using the Rate function of Cyclic Measurements. In Zoom View, the cursor is used to display a data value at a specific time point (the value of the selected channel is displayed above, along with the time point)

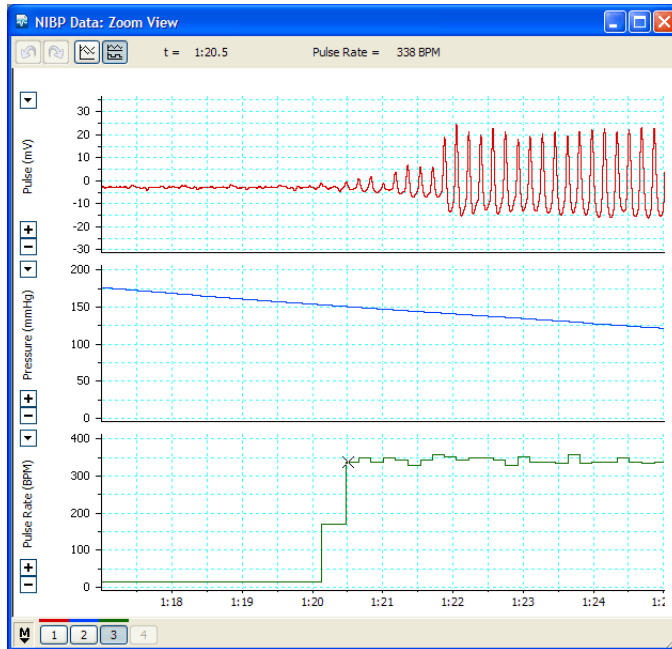

A large, stylized letter 'A' is the central focus of the header. It has a white outline and a grey fill. The background of the header is a light grey with diagonal stripes. The word 'APPENDIX' is written in a bold, sans-serif font above the 'A'.

Technical Details

■ This appendix describes some important technical aspects of the NIBP Controller operation. You do not need to know this material to use the NIBP Controller. It is likely to be of interest to the technically-minded and is not intended in any way as a service guide.

It should be noted that any modification or attempt to service your NIBP Controller voids your rights under the warranty.

How it Works

The NIBP Controller is a microprocessor controlled pump, designed to perform the cuff inflation and deflation sequence required for non-invasive blood pressure measurement. Internal amplifiers and filters are provided to allow monitoring of the cuff pressure and the subject's pulse so that systolic and diastolic pressure can be determined.

Circuit Principles

To understand the internal operation of the NIBP Controller, refer to Figure A-1, which shows a block diagram of the system.

Figure A-1
Block diagram of the
NIBP Controller

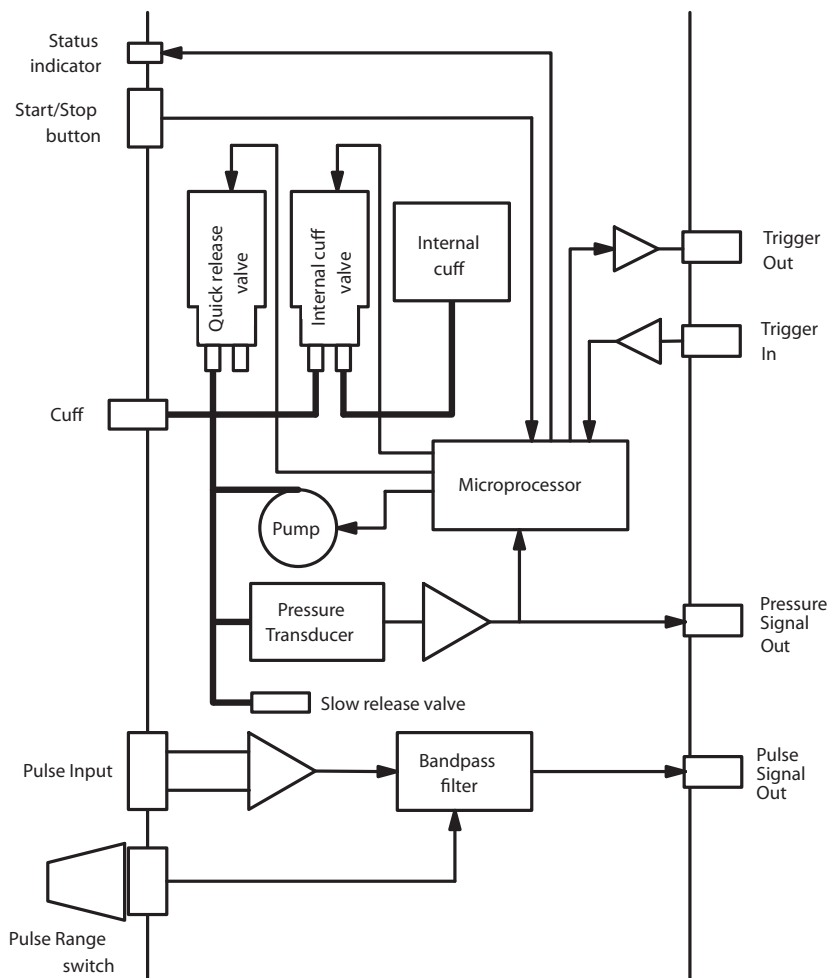

Pump Control

Control over the cuff inflation and deflation sequence is achieved using an internal microprocessor. The microprocessor waits until it detects a start signal either from the front Start/Stop button or from the external trigger input. It then turns on the internal pump and starts to fill the cuff. While pumping, it continuously monitors the cuff pressure and compares it to the maximum cuff pressure set on the back panel switch (either 200 mmHg or 280 mmHg). When this maximum cuff pressure is reached, the pump is switched off. The air in the cuff is allowed to escape at a predefined rate through a small release valve. The pressure will continue to decrease until it reaches about 35–40 mmHg, at which point a quick release solenoid will be opened to quickly release the residual air.

The inflation and deflation cycle can be stopped (or reset) at any time by pressing the Start/Stop button during the cycle. The microprocessor then opens the quick release valve and the pressure will return quickly to atmospheric. This takes about a second.

Pressure and Pulse Monitoring

In order to determine the systolic pressure the NIBP system provides two analog output signals for animal pulse and cuff pressure.

An internal pressure transducer is used to monitor the air pressure in the cuff air supply line. The output of the transducer is amplified and then provided as a signal from the rear panel on the controller. The NIBP Controller is factory calibrated to produce 1 volt output per 300 mmHg, with zero volts corresponding to zero pressure.

The pulse signal is recorded via the Pulse Input connection on the front panel of the NIBP Controller. This input connection is designed to allow different types of pulse transducers to be connected, depending on the application. For rats and mice the pulse transducer is incorporated with the tail cuff. The signal from the external pulse transducer is amplified and then band-pass filtered, before being passed to the pulse output connector on the rear panel.

Pulse signal filtering is achieved using a band-pass filter with preset frequencies depending on the Pulse Range setting on the front panel. The band-pass filter consists of an analog, second order (two pole) high-pass filter followed by an eighth order (switched capacitance) low-pass filter.

The Pulse Input Connector

This connector has provision for two types of analog input: a differential high-gain signal, or a single-ended low-gain signal. The differential input is used for small signals typically obtained from pulse transducers connected to rats and mice. The single-ended low gain input can be used for other pulse transducers that provide a larger signal. The pin assignments for the Pulse Input connector are shown in Figure A-2.

Figure A-2
The Pulse Input connector
pin assignments

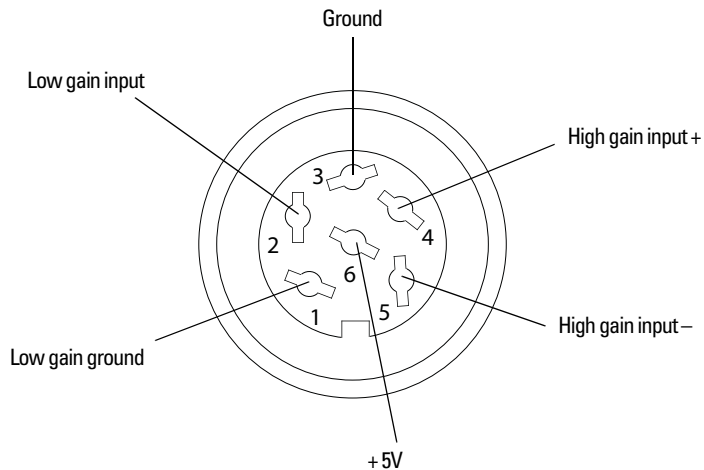

The Pulse Input connector provides a +5 V power supply (pin 6), which supplies excitation to the transducer, if required.

For transducers that produce very low level signals, such as those used for rats or mice, the high-gain differential inputs are used (pins 4 and 5). The output signal from the transducer should not exceed 250 μV . The output of the transducer should be connected between the high gain input + and high gain input - pins. To minimise noise, pins 1 and 2 should be shorted together.

For high output pulse transducers (up to 500 mV) you should use the single-ended low gain input (pins 1 and 2). If using this connection you should also ensure that pins 3, 4 and 5 are shorted together.

B

Specifications

Cycle Operation

Max Inflation Pressure:	200 or 280 mmHg (switch-selectable)
Measurement Cycle Time:	
40–150 BPM (large animals):	44 s (for 200 mmHg) 87 s (for 280 mmHg).
90–420 BPM (rats):	22 s (for 200 mmHg) 41 s (for 280 mmHg).
240–600 BPM (mice):	18 s (for 200 mmHg) 40 s (for 280 mmHg).
Cycle Control:	Microprocessor based. Performs inflation, deflation, and fast deflation sequences automatically.
Operation Indication:	Trigger output (normally low, but high during inflation and deflation cycle). Front panel Status indicator shows inflation and deflation operation.
Operation Abort:	The cycle can be terminated at any point by pressing the front panel Start/Stop button again. Pressure is automatically released.
Fast Release Time:	~1.2 s from 280 to 40 mmHg at 40–150 BPM ~0.5 s from 280 to 40 mmHg at higher ranges.
Control Sources:	Front panel push button; External signal source (voltage level); Remote contact closure.

Manual Start/Stop Input

Operation: Contact the closure input for starting or stopping measurement cycle. Shorting the input signal results in a start or stop operation.

Minimum Contact Closure: 1 ms

Remote Trigger Input

Operation: Voltage level input for starting or stopping NIBP cycle. TTL compatible input. High level operates a start/stop.

Input Voltage: 3–5 V

Minimum Trigger Pulse: 1 ms

Trigger Output

Operation: High (+5V) output level during measurement cycle. Otherwise zero.

Pressure Output (Cuff Pressure)

Sensitivity: 0–1 V : 0–300 mmHg (factory calibrated)

Frequency Response: DC to 10 Hz

Pulse Input

Input Impedance: Differential Input: 10 G Ω
Single-ended Input: 1 M Ω

Input Signal Range: High gain differential input: (0–25 μ V) up to (0–75 μ V), depending on rear panel Gain Adj setting.
Low gain single-ended input: (0–50 mV) up to (0–150 mV), depending on rear panel Gain Adj setting.

Bandwidth: 40–150 BPM:0.7–2.5 Hz
90–420 BPM:3–7 Hz
240–600 BPM:4–10 Hz

Pulse Output Max: \pm 5 V

Operating Requirements

Power Requirements: PowerLab or MacLab I²C interface:
+9 V @ 100 mA
±18 V @ 50 mA

Operating Conditions: 5–35 °C, 0–90% humidity (non condensing)

Physical Configuration

Dimensions (h × w × d): 65 mm × 200 mm × 275 mm
(2.56" × 7.9" × 10.8")

Weight: 1.7 kg

ADInstruments reserves the right to alter these specifications at any time.

Index

B

back panel 15
block diagram 26

C

circuit principles 26
cleaning 10
connecting
 pulse transducers 20
 to other front-ends 19
 to other recorders 19
 to PowerLab 18
Cuff pressure connection 14

F

filter switch 15
front panel 14

G

gain adjustment 16

H

how it works 26

I

indicators
 Power 14
 Status 14
Indirect blood pressure measurements 21
I2C connection 15

M

maintenance 10
maximum cuff pressure switch 16

P

Power indicator 14
power up testing 19
PowerLab connection 18
pressure and pulse monitoring 27
pressure output connection 16
Pulse Input connector 15, 28
pulse input gain adjustment 16
pulse output connection 15, 16
Pulse Range switch 15
pump control 27

S

Safety Notes 5–11
Start/Stop button 15
Status indicator 14
storage 10

T

Trigger controls 18
trigger input connection 16
trigger output connection 16

U

user modification voids warranty 25
using the NIBP Controller 19

