



**ADINSTRUMENTS**  
**RODENT LANGENDORFF**

Owner's Guide  
Isolated Heart Retrograde Perfusion Apparatus

This document is, as far as possible, accurate at the time of release. However, changes may have been made to the software and hardware it describes since then. ADInstruments NZ Limited reserves the right to alter specifications as required. Late-breaking information may be supplied separately.

### **Trademarks of ADInstruments**

PowerLab®, LabChart® and ADInstruments® are registered trademarks of ADInstruments NZ Limited.

### **Other Trademarks**

Apple, Mac and Macintosh are registered trademarks of Apple Computer, Inc.

Windows, Windows 7, Windows 8, Windows 10 and Windows Vista are either registered trademarks or trademarks of Microsoft Corporation.

All other trademarks are the property of their respective owners.

Document Number: U-LNG/OG-01A. Date of issue: 6/2023

Copyright © ADInstruments NZ Limited, 2023. All rights reserved. PowerLab, LabChart and ADInstruments are registered trademarks of ADInstruments NZ Limited. Windows 8, Windows 7, Windows 10, Windows Vista and .NET Framework are trademarks of Microsoft Corporation. Apple, the Apple logo, MacOS, and Macintosh are trademarks of Apple Computer Inc. registered in the U.S. and other countries. All other trademarks are the property of their respective owners.

Web: [www.adinstruments.com](http://www.adinstruments.com)

Manufactured in Australia for:  
ADInstruments NZ Limited,  
77 Vogel Street  
Dunedin 9016, New Zealand

Technical Support: [support.au@adinstruments.com](mailto:support.au@adinstruments.com)



# Contents

<b>1 Safety Notes</b>	<b>1</b>
Statement of Intended Use .....	1
Safety and Quality Standards .....	1
General Safety Instructions .....	3
Cleaning and Sterilization .....	4
Inspection and Maintenance .....	4
Environment .....	5
Transport and Storage Conditions.....	5
Operating Conditions.....	5
Disposal.....	5
<b>2 Introduction</b>	<b>6</b>
<b>3 Apparatus</b>	<b>7</b>
Apparatus Components .....	8
Electronic Components.....	12
Measurement Hardware.....	13
Apparatus Assembly .....	15
Glassware Assembly .....	15
Water Jacketing Assembly.....	18
Gas Tubing Connections.....	21
Spill Tray Placement .....	21
Perfusion Connections.....	22
Pressure Line Damping.....	22
Aortic Cannula Connection Options .....	23
Perfusion Core Side Port Options .....	23
Drain Connection Options.....	23
Buffer Filling.....	24
Priming .....	25

<b>4</b>	<b>Electronics Setup</b>	<b>26</b>
	Water Heating .....	27
	Perfusion .....	27
	Peristaltic Pump .....	27
	Peristaltic Pump Controller.....	28
	Perfusion Pressure .....	30
	Left Ventricular Pressure .....	31
	Apical Force Measurement (Optional).....	32
	Perfusate Temperature .....	33
	ECG .....	34
	Measuring pH, O <sub>2</sub> and CO <sub>2</sub> (Optional) .....	35
	Software Installation .....	36
	LabChart 8.....	36
	LabChart Lightning .....	36
	Connecting the PowerLab to the Computer .....	36
<b>5</b>	<b>Calibration and Testing</b>	<b>38</b>
	Testing the Electronics .....	39
	Power Up Self-test with LabChart 8.....	39
	Power Up Self-test with LabChart Lightning .....	39
	Testing the STH Pump Controller.....	40
	STH Pump Controller Pressure Gain Adjustment .....	40
	Calibration .....	41
	Perfusion Pressure Calibration.....	41
	Flow Calibration.....	43
	Testing the Langendorff System.....	45
<b>6</b>	<b>Cleaning</b>	<b>47</b>
	Cleaning .....	48
	General Cleaning Tips.....	48
	Cleaning Glass Items.....	49
	Cleaning Non-Glass Items .....	50
	Tubing Maintenance .....	50
<b>7</b>	<b>Warranty</b>	<b>51</b>



## Chapter 1

# Safety Notes



## Statement of Intended Use

All products manufactured by ADInstruments are intended for use in teaching and research applications and environments only. ADInstruments products are NOT intended to be used as medical devices or in medical environments. That is, no product supplied by ADInstruments is intended to be used to diagnose, treat or monitor a subject. Furthermore no product is intended for the prevention, curing or alleviation of disease, injury or handicap. ADInstruments products are intended to be installed, used and operated under the supervision of an appropriately qualified life-science researcher. The typical usage environment is a research or teaching lab or hospital. ADInstruments equipment is not intended for use in domestic environments.

Where a product meets IEC 60601-1 it is under the principle that:

- this is a more rigorous standard than other standards that could be chosen.
- it provides a high safety level for subjects and operators.

The choice to meet IEC 60601-1 is in no way to be interpreted to mean that a product:

- is a medical device,
- may be interpreted as a medical device, or
- is safe to be used as a medical device.

## Safety and Quality Standards

In accordance with European standards PowerLab C and C Series devices also comply with the electromagnetic compatibility requirements under EN61326-1, which encompasses the EMC directive.

### **Quality Management System ISO 9001:2015**

ADInstruments manufactures products under a quality system certified as complying with ISO 9001:2015 by an accredited certification body.

# Regulatory Symbols

Devices manufactured by ADInstruments that are designed for direct connection to humans and animals are tested to IEC60601-1:1998 and IEC60601-1:2005 (including amendments 1 and 2) and EN61326-1:2006, and carry one or more of the safety symbols below.



**Warning symbol.** The exclamation mark inside a triangle means that the supplied documentation must be consulted for operating, cautionary or safety information before using the device.



**CE Mark.** All front-end amplifiers and PowerLab systems carry the CE mark and meet the appropriate EU directives.



**UKCA Mark.** All front-end amplifiers and PowerLab systems carry the UKCA mark and meet the appropriate UK directives.



**Refer to booklet symbol.** This symbol specifies that the user needs to refer to the Instruction manual or the booklet associated with the device.



**Date of Manufacture/ Manufacturer's name symbol.** This symbol indicates the date of manufacture of the device and the name of the manufacturer



**WEEE directive symbol.** Unwanted equipment bearing the Waste Electrical and Electronic Equipment (WEEE) Directive symbol requires separate waste collection. (See disposal section at the end of this chapter)

Further information is available on request.

## Safety Standards

### IEC Standard - International Standard - Medical Electrical Equipment

IEC 60601-1:2012

General requirements for safety





**WARNING:**

This equipment is not intended to be modified or serviced by the user. No user serviceable parts inside. Refer servicing to authorized ADInstruments service center.



**WARNING:**

Use only with ADI supplied power cords appropriate for your region.

## General Safety Instructions

To achieve the optimal degree of subject and operator safety, consideration should be given to the following guidelines when setting up a PowerLab C either as stand-alone equipment or when using PowerLab equipment in conjunction with other equipment. Failure to do so may compromise the inherent safety measures designed into PowerLab equipment.

The following guidelines are based on principles outlined in the international safety standard IEC 60601-1: *General requirements for safety – Collateral standard: Safety requirements for medical systems*. Reference to this standard is required when setting up a system for human connection. The user is responsible for ensuring any particular configuration of equipment complies with IEC60601-1-1.

The PowerLab C (and many other devices) requires the connection of a personal computer for operation. This personal computer should be certified as complying with IEC 60950 and should be located outside a 1.8 m radius from the subject (so that the subject cannot touch it while connected to the system). Within this 1.8 m radius, only equipment complying with IEC 60601-1 should be present. Connecting a system in this way obviates the provision of additional safety measures and the measurement of leakage currents.

Accompanying documents for each piece of equipment in the system should be thoroughly examined prior to connection of the system.

While it is not possible to cover all arrangements of equipment in a system, some general guidelines for safe use of the equipment are presented below:

- Any electrical equipment which is located within the SUBJECT AREA should be approved to IEC 60601-1.
- Do not touch the subject to which the PowerLab (or its peripherals) is connected at the same time as making contact with parts of the PowerLab (or its peripherals) that are not intended for contact to the subject.
- Cleaning and sterilization of equipment should be performed in accordance with manufacturer's instructions. The isolation barrier may be compromised if manufacturer's cleaning instructions are not followed.
- The ambient environment (such as the temperature and relative humidity) of the system should be kept within the manufacturer's specified range or the isolation barrier may be compromised.
- The entry of liquids into equipment may also compromise the isolation barrier. If spillage occurs, ADInstruments should be contacted before using the equipment.
- The PowerLab depends on the presence of a Protective Earth for its electrical safety requirement. This is usually provided from the power outlet through a power cord. Before connecting the equipment to mains power, ensure that the power socket has a protective earth circuit capable of carrying the fault current (see bullet point below). Note the POAG terminal on the rear of the PowerLab C is not rated as a Protective Earth.
- The Protective Earth must be cable of carrying the maximum current allowed by the circuit breaker and must be electrically insulated. It must be connected to

**WARNING:**

To avoid risk of electric shock, this equipment must only be connected to a supply mains with protective earth

an equi-potential source (a metal stake drive into the soil is a typical situation). A licensed electrician must perform this installation.

- Power cords should never be modified so as to remove the earth connection. The integrity of the Protective Earth connection between each piece of equipment and the Protective Earth should be verified regularly by qualified personnel.
- PowerLabs are compatible with electrical safety devices (sometimes known as Safety Switches, Ground fault circuit interruptor, Residual Current Devices or Earth-leakage Circuit Breaker). ADInstruments recommends the use of such devices supplied in fixed wiring installations.
- Avoid using multiple portable socket-outlets (such as power boards) where possible as they provide an inherently less safe environment with respect to electrical hazards. Individual connection of each piece of equipment to fixed mains socket-outlets is the preferred means of connection.
- When used in ambient temperatures of 38 degrees Celcius and above, do not touch PowerLab enclosure or the USB cable continuously for more than a minute.
- To safely shut down the PowerLab, press the stop button and then close LabChart. Turn the PowerLab off at the inlet switch.

If multiple portable socket outlets are used, they are subject to the following constraints:

- They shall not be placed on the floor.
- Additional multiple portable socket outlets or extension cords shall not be connected to the system.
- They shall only be used for supplying power to equipment which is intended to form part of the system.

## Cleaning and Sterilization

ADInstruments products may be wiped down with a lint free cloth moistened with industrial methylated spirit.

## Inspection and Maintenance

PowerLab systems and ADInstruments front-ends are all maintenance-free and do not require periodic calibration or adjustment to ensure safe operation. Internal diagnostic software performs system checks during power up and will report errors if a significant problem is found. There is no need to open the instrument for inspection or maintenance, and doing so within the warranty period will void the warranty.

The PowerLab system can be periodically checked for basic safety by using an appropriate safety testing device. Tests such as earth leakage, earth bond, insulation resistance, subject leakage and auxiliary currents and power cable integrity can all be performed on the PowerLab system without having to remove the covers. Follow the instructions for the testing device if performing such tests. If the PowerLab system is found not to comply with such testing you should contact your ADInstruments representative to arrange for the equipment to be checked and serviced.



---

# Environment

Electronic components are susceptible to corrosive substances and atmospheres, and must be kept away from laboratory chemicals.

## Transport and Storage Conditions

- Temperature in the range 0–40 °C
- Non-condensing humidity in the range 0–95%.

## Operating Conditions

- Temperature in the range 5–35 °C
- Non-condensing humidity in the range 0–90%.

## Disposal

- Forward to recycling center or return to manufacturer.
- Unwanted equipment bearing the Waste Electrical and Electronic Equipment (WEEE) Directive symbol requires separate waste collection. For a product labeled with this symbol, either forward to a recycling center or contact your nearest ADInstruments representative for methods of disposal at the end of its working life.



WEEE Directive  
symbol



## Chapter 2

# Introduction

Isolated Langendorff heart preparations have been used for over a hundred years, providing researchers with convenient physiological models that can be studied without the systemic influences of the intact animal. Additionally, these preparations allow control over factors such as temperature, perfusate, oxygen, and drug concentrations. Hence, associated studies have provided valuable insights and significantly contributed to the understanding of the inherent nature of the heart. Therefore, for many years, ADInstruments have partnered with gold-standard manufacturers of isolated heart apparatuses to provide researchers with comprehensive solutions.

Continuing our mission to Make Science Easier, we have worked with Radnoti LLC to provide a high-quality apparatus with the greatest flexibility, while being presented in a relatively compact design. This design leverages over 30 years of combined experience in interacting with, supporting, and listening to feedback from researchers. It features high-quality borosilicate glassware components, corrosion-resistant stainless-steel supports, fine gassing control, recirculating buffer overflow options, comprehensive water jacketing for temperature control and maintenance, and options to study a variety of isolated animal heart sizes, including, mice, rats, and guinea-pigs.



## Chapter 3

# Apparatus



**WARNING:**

Several Langendorff apparatus components are made of glass and require care during handling.

This chapter describes in detail how to set up the Langendorff apparatus, including the components of the heating and perfusion subsystems.









**PLEASE NOTE:** Several components of the Langendorff apparatus are made of glass. Please ensure you read the special guidelines for the care of this system, included in Chapter 6. Please read them. Failure to follow these guidelines could invalidate any warranty claims.

# Apparatus Components









The Langendorff apparatus has many components, as shown in Table 2-1. Familiarizing yourself with the names used for these components will help you to follow the instructions in this manual.

**Table 3-1**

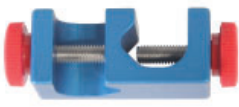
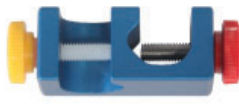
The components required to complete the basic assembly of the Langendorff apparatus

Part No.	Description	Qty	Image
159950-B2	Steel Base for 2-Rod Lab Stand	1	
159950-24	Stainless Steel Support Rod (24")	2	
120142-1	Radnoti 1.0 L Water Jacketed Reservoir	2	
140150-PHC	Direct Perfusion Core Luer Port Couplers Rubber Port Couplers	1	
130163-14	Aortic Cannula Tip (14 Gauge)	1	
130163-16	Aortic Cannula Tip (16 Gauge)	1	
130163-20	Aortic Cannula Tip (20 Gauge)	1	
130163-22	Aortic Cannula Tip (22 Gauge)	1	

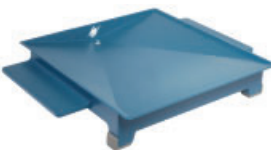
Part No.	Description	Qty	Image
140150	Radnoti Hi-Tech Heart Chamber (Small)	1	
140150-001-CHS	Heart Chamber Lid	1	
140150-002	Apical Force Pulley Assembly	1	
140132	Radnoti Female (24 mm) Port to Luer Adapter	1	
140143-1	Oxygenating Bubbler with Inlet for 1 L Reservoir	2	
120168	Radnoti 2-Way TNV "Y" Manifold	1	
120140-A	Radnoti Reservoir Filling Funnel	1	

Part No.	Description	Qty	Image
120141-1	Double Ring Clamp for 1 L Reservoir	2	
159953-10	Single Ring Clamp for Perfusion Core (Diameter 38-45 mm)	1	
159953-MEM	Single Ring Clamp for Radnoti Hi-Tech Heart Chamber (Small)	1	
159952	Radnoti Universal Stand Clamp (SSteel)	6	
159952-G	Radnoti Universal Stand Clamp (Nylon)	1	
120169-2	Hose Barb Adapter (Pump to Q.D. Water Jacketed Tubing, 2pk)	2	
140150-002W	Heart Chamber Pulley Assembly Wire (1m)	1	
120162-1	“Y” Adapter Quick Disconnect Manifold (1pk)	2	
MLA2820	Stand Base Spill Tray (3 Rod)	1	
	20 mL Damping Syringe)	1	



Part No.	Description	Qty	Image
120159-20	Radnoti Q.D. Water Jacketed Tubing Assembly (20")	4	
120159-30	Radnoti Q.D. Water Jacketed Tubing Assembly (30")	2	
120159-70	Radnoti Q.D. Water Jacketed Tubing Assembly (70")	2	
120157-12	Radnoti Tygon Perfusate/Gas Tubing (0.093" x 0.156", 12")	1	
120157-24	Radnoti Tygon Perfusate/Gas Tubing (0.093" x 0.156", 24")	2	
120157-36	Radnoti Tygon Perfusate/Gas Tubing (0.093" x 0.156", 36")	6	
120157-70	Radnoti Tygon Perfusate/Gas Tubing (0.093" x 0.156", 70")	1	
120155-188-50	Radnoti Silicone Drain/Overflow Tubing (0.188" x 0.375", 50")	1	
120140-B-	Radnoti Tubing Adapter Kit	1	
120152	Septa (Silicone, White, 7.84 mm, 10 pk)	1	
	Ball End Hex Screwdriver & Allen Key	1	

**NOTE:**

Image shows external and internal views.

# Electronic Components

The Langendorff apparatus requires several electronic hardware to operate. The following components may be supplied depending on the purchased configuration.

PLEASE NOTE: Required PowerLab is not shown and C series Signal Conditioners will be supplied with a Front End Interface.

**Table 3-2**

The components required to complete the basic assembly of the Langendorff apparatus

Part No.	Description	Qty	Image
MLA212	Heated Water Recirculator	1	
170113	Radnoti Pump Head (6 Roller) 2x Mounting Bolt Screws 1x Tubing with barbed Luer Adapters	1	
170600	Peristaltic Pump Drive (20-600 rpm, Dual Voltage)	1	
IN175	STH Pump Controller	1	
MLAC66	STH Pump Controller to Radnoti Peristaltic Pump Cable	1	
FE221 or FE224	Bridge Amp or Quad Bridge Amp	1	
MLT844	Physiological Pressure Transducer	1	

**NOTE:**

A Bridge Amp or Quad Bridge Amp may be supplied depending on the required purchased configuration.









## Measurement Hardware



The Langendorff apparatus require the following compatible hardware to measure cardiovascular parameters from the isolated heart. Some may be supplied depending on the purchased configuration.

PLEASE NOTE: C series Signal Conditioners will be supplied with a Front End Interface. Additionally, quantities will vary according to the purchased configuration.

**Table 3-3**

The hardware components to measure parameters from an isolated heart maintained by a functional Langendorff apparatus assembly.

Part No.	Description	Qty	Image
FE305	Pod Expander	1	
ML312	T-type Pod	1	
MLT1401	T-type Implantable Thermocouple Probe (IT-18)	1	
FE231	Bio Amp	1	
MLA1212	Micro-Hook Electrodes (1.5mm, 3 pk)	1	
MLA1213	Needle Electrodes (29 ga, 1.5mm Socket, 3 pk)	1	
MLA1214	Spring Clip Electrodes (1.5mm Socket, 3 pk)	1	
MV-ADPT-DIN	Millivolt Adapter (DIN)	2	
O2-ADPT100-DIN	O2 Adapter (100, DIN)	1	

Part No.	Description	Qty	Image
RGT-MI-410	Combination pH Microelectrode (Dip-Type, RGT)	1	
RGT-MI-720	Carbon Dioxide Microelectrode (Dip-Type, RGT)	1	
RGT-MI-730	Oxygen Microelectrode (Dip-Type, RGT)	1	

# Apparatus Assembly

This section describes and illustrates how to assemble the apparatus of the Langendorff system.

## Glassware Assembly

1. Place the Steel Base for 2 Rod Lab Stand on the intended bench space. If possible, select an area that will allow for accidental spills. Attach the threaded ends of each Stainless Steel Support Rod (24") to the outer threaded holes of the Steel Base for 2 Rod Lab Stand.



Threaded end of a Stainless Steel Support Rod

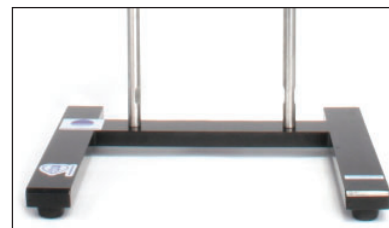

Attaching Stainless Steel Support Rods to Steel Base

### NOTE:

The second reservoir need not be installed if the protocol does not require a second reservoir.

2. Familiarize yourself with the attaching/detaching mechanism of the Double Ring Clamp for 1 L Reservoir, which is effectively a hose-clamp. Rotate both tightening/loosening knob screws to loosen both perforated bands until they are completely disconnected from their respective slots.
3. Orientate each Radnoti 1.0 L Water Jacketed Reservoir so that its outflow port is positioned near the front. This is highly recommended as it provides easier access from the front. Correspondingly, first orientate the Double Ring Clamp for 1 L Reservoir so the tightening/loosening knob screws are facing the back. Fit the bands of the double ring clamp around the reservoir. Push each band against its slot and rotate the knob screw to catch and tighten the band.
4. Place two Radnoti Universal Stand Clamp (SSteel) on each Stainless Steel Support Rod (24") with their distance matching the distance between the support rods of a Double Ring Clamp for 1 L Reservoir.

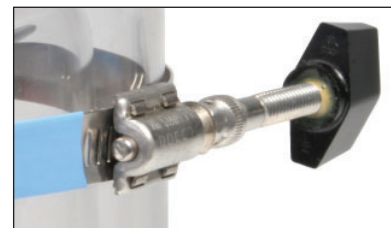

Assembling Double Ring Clamp around Reservoir



Orientating and securing Double Ring Clamp

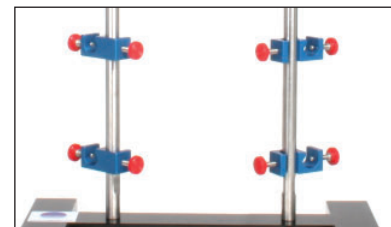

Placing Universal Stand Clamp (SSteel) on each Support Rod

5. Attach each double ring clamp with reservoir to each stainless steel support rod.



Attaching an assembled Water Jacketed Reservoir on the right Support Rod



Attaching the other assembled Water Jacketed Reservoir on the left Support Rod

6. Similarly, attach the Single Ring Clamp for Radnoti Hi-Tech Heart Chamber (Small) to the Radnoti Hi-Tech Heart Chamber (Small). Place a Radnoti Universal Stand Clamp (SSteel) on either stainless steel support rod. Attach the single ring clamp with the heart chamber to it.
7. Connect the Radnoti Female (24 mm) Port to Luer Adapter to the bottom of the heart chamber.
8. Assemble the Direct Perfusion Core by gently and firmly sliding the Heart Chamber Lid onto the cylindrical glass sheath at the bottom of the Perfusion Core. Afterwards, a 3-Way Tap can also be attached to the outlet at the bottom of the Perfusion Core (see later section **Aortic Cannula Connection Options**).
9. Attach the Single Ring Clamp for Perfusion Core (Diameter 38-45 mm) to the Direct Perfusion Core. Gently attach the Heart Chamber Lid to the Direct Perfusion Core. Attach this assembly to the stainless steel support rod via another Radnoti Universal Stand Clamp (SSteel).
10. Next attach the Radnoti 2-Way TNV “Y” Manifold via a Radnoti Universal Stand Clamp (Nylon). Ensure the nylon screw is used to attach the manifold.
11. Lastly, the large black cap from the top of each Water Jacketed Reservoir can be removed. An Oxygenating Bubbler with Inlet for 1 L Reservoir inserted can be inserted and secured by screwing on its threaded cap.



Attaching assembled Heart Chamber to a Support Rod

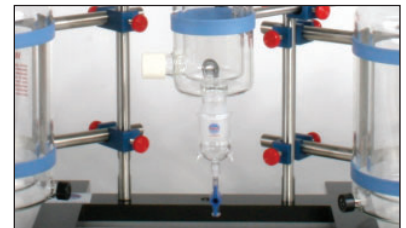

Attaching Female (24 mm) Port to Luer Adapter to Heart Chamber



Attaching assembled Direct Perfusion Core to Support Rod



**Figure 3-1**

Overview of assembling the apparatus, including base, support rods and glassware

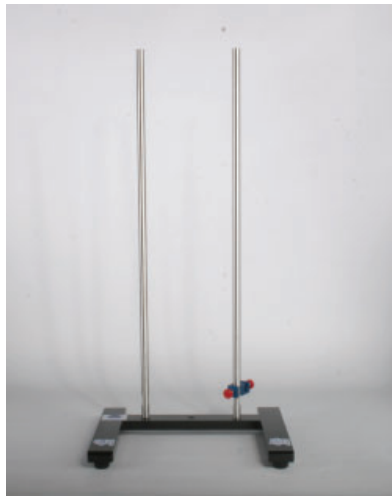

**Assembling Steel Base, Support Rods, and attaching a Universal Stand Clamp (SSteel)**



**Assembling and attaching a Water Jacketed Reservoir**



**Similarly attaching another Water Jacketed Reservoir**



**Attaching the Hi-Tech Heart Chamber**



**Attaching the Perfusion Core with the Heart Chamber Lid**



**Attaching the Universal Stand Clamp (Nylon) for the 2-Way TNV "Y" Manifold**

## Water Jacketing Assembly

1. First remove the protective caps from the threaded glass end of each Hose Barb Adapter (Pump to Q.D. Water Jacketed Tubing). Using one Hose Barb Adapter (Pump to Q.D. Water Jacketed Tubing), carefully insert one end of a Radnoti Q.D. Water Jacketed Tubing Assembly (70") and carefully fasten it by screwing the drill cap onto the threaded glass end.

**Figure 3-2**

Connecting a Quick Disconnect Water Jacketing Tubing Assembly to a Hose Barb Adapter

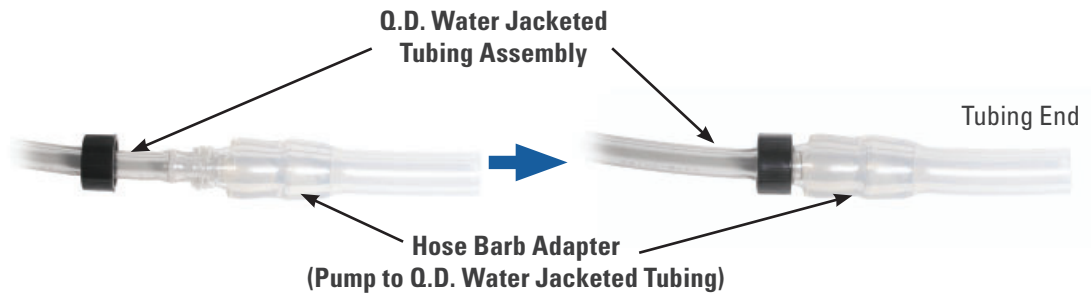

2. Identify the inlet and outlet of the Heated Water Recirculator. Connect the Hose Barb Adapter with the connected Water Jacketed Tubing Assembly (70") to the outlet of the recirculator via the tubing end of the Hose Barb Adapter.

**Figure 3-3**

Connecting to Heated Water Recirculator

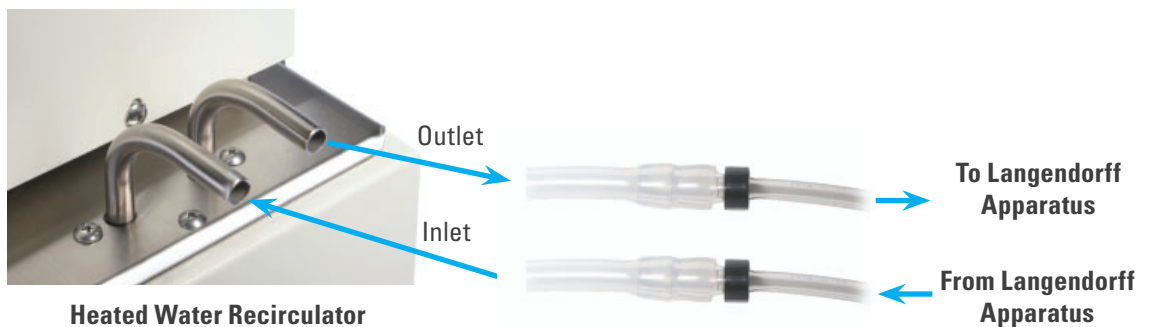

**NOTE:**

The apparatus is designed to be compatible with a range of water bath recirculators, including the Radnoti Thermal Bath/Circulator.

3. Remove any protective drill caps on the input and output of the Radnoti Hi-Tech Heart Chamber (Small). Insert and attach the other free end of the Water Jacketed Tubing Assembly (70") to the threaded water jacketing inlet (at the side bottom) of the heart chamber.
4. Insert and attach one end of the Radnoti Q.D. Water Jacketed Tubing Assembly (20") to the threaded water jacketing outlet (at the side top) of the heart chamber. Similarly, ensure that any protective drill caps are removed from the Direct Perfusion Core. Connect the other free end of the Water Jacketed Tubing Assembly (20") to the threaded water jacketing inlet (at the side bottom) of the Direct Perfusion Core.



Connecting to Heart Chamber's inlet



Connecting Heart Chamber to Perfusion Core

**NOTE:**

The “Y” Adapter Quick Disconnect Manifold will not be required if only installing a single reservoir.

5. Insert and attach one end of another Radnoti Q.D. Water Jacketed Tubing Assembly (20”) to the threaded water jacketing outlet (at the side top) of the Direct Perfusion Core. Remove any protective caps from a “Y” Adapter Quick Disconnect Manifold. Connect the other free end of the Water Jacketed Tubing Assembly (20”) to that manifold.
6. Remove any protective drill caps from the Water Jacketing Reservoir. Connect each of the other two ends of the manifold to a threaded water jacketing inlet (at the side bottom) of the Water Jacketed Reservoir via a Water Jacketed Tubing Assembly (20”).
7. Connect both the threaded water jacketing outlet (at the side top) of the Water Jacketed Reservoirs to another “Y” Adapter Quick Disconnect Manifold via Water Jacketed Tubing Assembly (30”), hence joining them. Connect the other free end of the manifold to a Water Jacketed Tubing Assembly (70”).
8. Connect the free end of this Water Jacketed Tubing Assembly (70”) to the other available Hose Barb Adapter (Pump to Q.D. Water Jacketed Tubing). Attach the tubing end of this Hose Barb Adapter to the inlet of the Heated Water Recirculator.

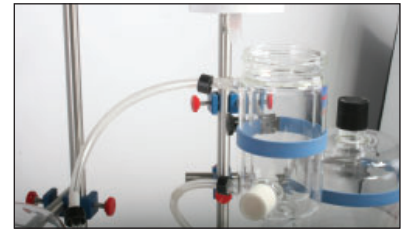

**Connecting from Perfusion Core’s outlet**



**Connecting to Reservoir’s inlet**

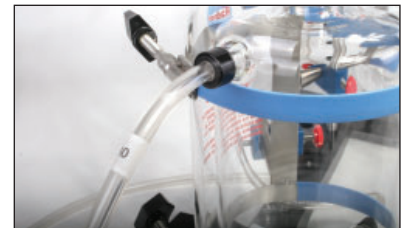

**Connecting from Reservoir’s outlet**

**Figure 3-4**

Water Jacket Tubing Connections

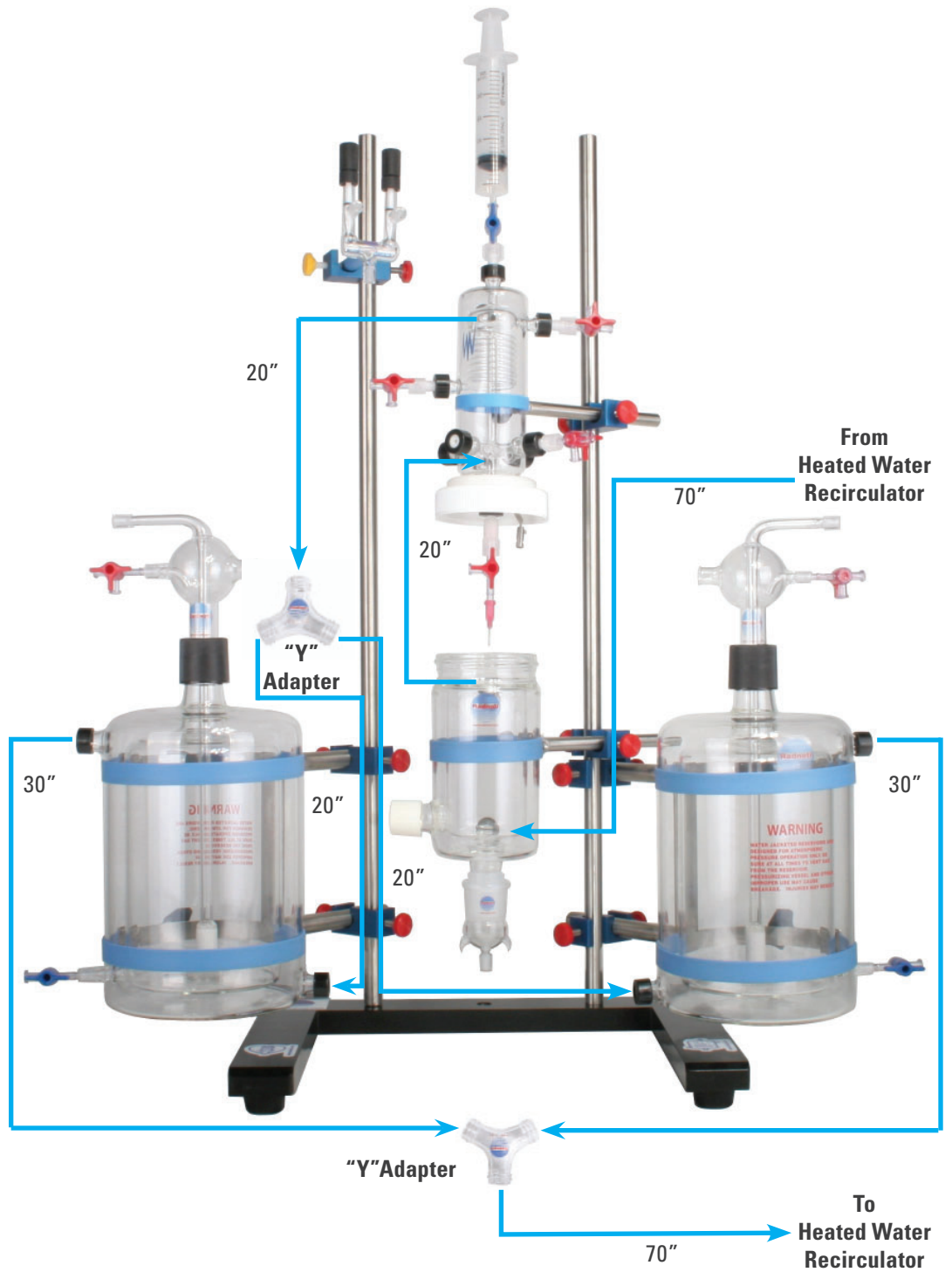

## Gas Tubing Connections

### NOTE:

Additional gas accessories might be required, which can include gas regulators, inlet and outlet fittings (i.e. 3/8" NPT to Gas Hose Barb Fitting, Tubing Reducer etc.). They should be separately and locally sourced according to the laboratory requirements.

Figure 3-5

Connecting gas tubings

1. First connect one end of the Radnoti Tygon Perfusate/Gas Tubing (0.093" x 0.156", 70") to a gas supply (not supplied). Further adaptation or adaptors may be required to fit it to the gas supply.
2. Connect the other free end of the Radnoti Tygon Perfusate/Gas Tubing to the central bottom port of the Radnoti 2-Way TNV "Y" Manifold.
3. Connect one end of each Radnoti Tygon Perfusate/Gas Tubing (0.093" x 0.156", 36") to each port of the manifold that is near to a teflon needle valve.
4. Connect the free end of each Radnoti Tygon Perfusate/Gas Tubing (0.093" x 0.156", 36") to the port of each Oxygenating Bubbler with Inlet for 1 L Reservoir that connects to its sintered glass gas dispersion tube.
5. Fill the reservoir with the desired buffer (please see Buffer Filling).
6. Turn on the gas supply. Minor gas flow adjustments can be made by turning the tap on the Gas Bubbler or by rotating each teflon needle valve.
7. Gas the buffer for at least 20-30 minutes before use (recommended).

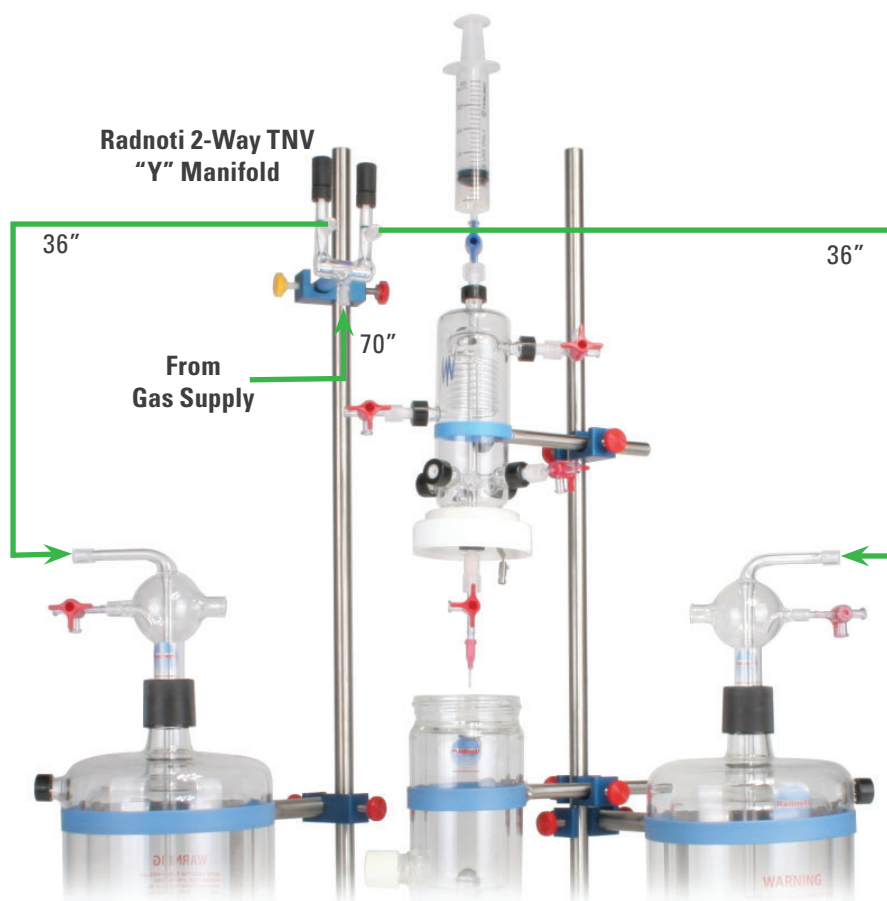

## Spill Tray Placement

1. Carefully connect the drain tubing to the plastic hose adapter, which is then inserted into its slot at the bottom of the spill tray. Slip the drain tubing to one side under the steel base and slide the spill tray so that its sides rest on the base.



## Perfusion Connections

### NOTE:

A 1-Way Tap connected to the outlet of each Radnoti 1.0 L Water Jacketed Reservoir is recommended for additional control of the buffer flowing out from each reservoir.

1. Confirm the placement of the assembled perfusion pump in relation to the rest of the Langendorff apparatus. Connect the pump's power supply and turn the pump on. Note the direction of rotation.
2. Connect a Radnoti Tygon Perfusate/Gas Tubing (0.093" x 0.156", 36) to the outlet of the reservoir furthest away from the pump and Radnoti Tygon Perfusate/Gas Tubing (0.093" x 0.156", 24) to the outlet of the reservoir closest to the pump. Join the free ends of each tubing to a female luer of a 3-Way Tap. Connect the male luer of the 3-Way Tap to the appropriate end of the pump tubing. This will correspond to the correct direction of rotation, which will draw in the buffer.
3. Connect the other end of the pump tubing to a Radnoti Tygon Perfusate/Gas Tubing (0.093" x 0.156", 36). If required, a disposable filter may be placed in between here.
4. Connect the other end of the Radnoti Tygon Perfusate/Gas Tubing (0.093" x 0.156", 36) to the inlet of the Direct Perfusion Core. Another 3-Way Tap can also be placed in between here for additional control.
5. Connect a 3-Way Tap to the overflow outlet of the Direct Perfusion Core. Next connect each female luer of this 3-Way Tap to the each Oxygenating Bubbler (female luer that flows into the reservoir) via a Radnoti Tygon Perfusate/Gas Tubing (0.093" x 0.156", 36). Another 3-Way Tap can also be placed in at the Oxygenating Bubbler for additional control or options, such as redirecting the overflow elsewhere if required.
6. Attach appropriate couplers to the side ports of the Perfusion Core (see section **Perfusion Core Side Port Options** later in this chapter).
7. Connections for measurement options from the Perfusion Core, such as **Perfusate Pressure**, are described in Chapter 4.

## Pressure Line Damping

1. Fit the supplied 20 mL Damping Syringe to the top of the Direct Perfusion Core to further reduce the pressure oscillations in the perfusion circuit that are caused by the rollers of the pump.
2. Adjust the syringe plunger and align the holes in the syringe barrel and plunger, so as to contain about 10 mL of air in the syringe. Push the supply metal rod through the holes in the barrel and plunger to prevent the plunger from moving when the system becomes pressurized.
3. A 1-Way Tap may be also placed in between the syringe and the Perfusion Core to provide additional control during experiments.



Connecting Damping Syringe to the Direct Perfusion Core



## Aortic Cannula Connection Options

1. Four aortic cannula tips of different sizes are supplied. Select the appropriate sized cannula and attach it to the bottom locking luer of the Direct Perfusion Core.
2. A 3-Way Tap may be placed in between the Direct Perfusion Core and the aortic cannula tip to either provide additional control or an additional access port closer to an isolated heart.



Aortic cannula tips

## Perfusion Core Side Port Options

1. The Perfusion Core has four side ports. Depending on the connecting sensor, appropriately select and attach either a Luer Port or Rubber Port Coupler.
2. A side port can be turned into an injection port by fitting a rubber septa into a drilled cap and screwed in place.
3. Seal any unused ports with a closed cap.



External and internal view of Luer (top row) and Rubber (bottom row) Port Couplers

## Drain Connection Options

1. The apparatus is designed to provide several waste disposal options. A standard option is to allow effluent to drain as waste from Radnoti Female (24 mm) Port to Luer Adapter into the Stand Base Spill Tray (3 Rod). A short piece of tubing may be cut from the Radnoti Silicone Drain/Overflow Tubing (0.188" x 0.375", 50") and connected to the Port to Luer Adapter to reduce the splash of the effluent.
2. Taps (1-Way or 3-Way) may be connected in between the Radnoti Female (24 mm) Port to Luer Adapter and drain tubing for a variety of purposes, including additional control or collection of effluent for sampling.

Figure 3-6

Drain connection options

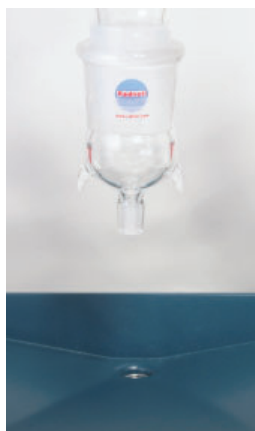

without taps



with 1-Way Tap



with 3-Way Tap

**Figure 3-7**

Connecting perfusate tubings for perfusion

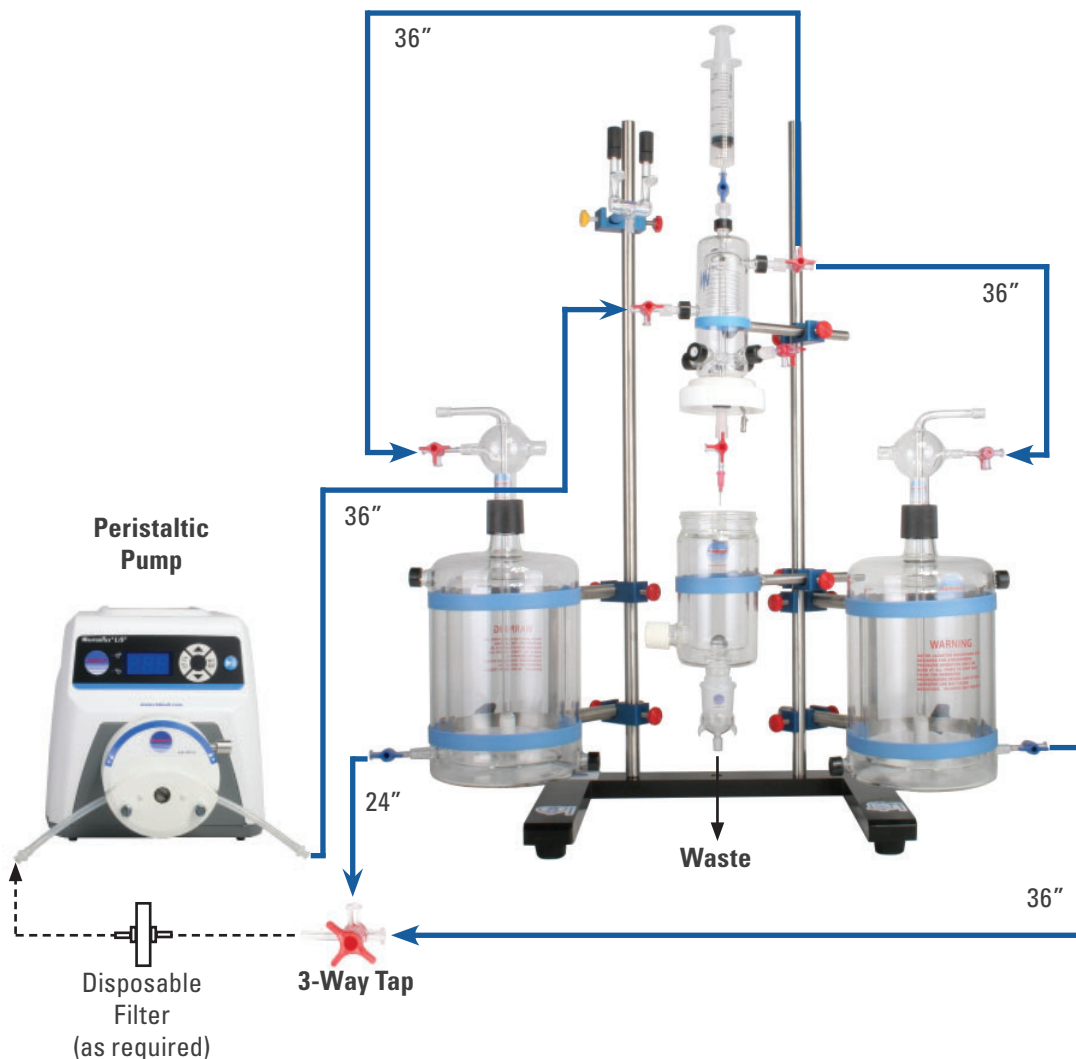

### Buffer Filling

1. Ensure that the apparatus is fully assembled, clean and ready. Next, ensure that the taps connected to the outlet of each Water Jacketed Reservoir are closed.
2. Release and lift the Oxygenating Bubbler with Inlet from a Water Jacketed Reservoir. Insert the Reservoir Filling Funnel and fill the reservoir with the desired volume of buffer.
3. Remove the Reservoir Filling Funnel and insert the Oxygenating Bubbler with Inlet back again into the reservoir. Repeat with the other reservoir.
4. Turn on the gas and begin gassing the reservoir with 95/5% O<sub>2</sub>/CO<sub>2</sub> to maintain gas tension and buffer pH level.

---

## Priming

1. Ensure that both the Peristaltic Pump and Peristaltic Pump Controller are properly set up as outlined in Chapter 4.
2. Note the Peristaltic Pump's rotation setting and ensure that Pump Tubing is securely placed in the right alignment that will pump buffer out from the reservoir as the pump drive turns.
3. Ensure there is sufficient buffer in the reservoir.
4. Open any taps used in the circuit, such if one is placed at the reservoir outlet and another before the inlet of the Direct Perfusion Core.
5. Ensure any taps used at the outlets of Direct Perfusion Core are closed, except for the top that connects to the 20 mL Damping Syringe and the bottom that connects to the aortic cannula.
6. Temporarily disconnect the 20 mL Damping Syringe with its tap.
7. Either start the Peristaltic Pump manually or via the Peristaltic Pump Controller to pump the buffer up to the Direct Perfusion Core (see sections **Peristaltic Pump** and **Peristaltic Pump Controller** in Chapter 4). Ensure pumping speed is sufficient to fill the Perfusion Core.
8. Fill the Direct Perfusion Core and release any trapped air bubbles through its top.
9. Close the tap at the aortic cannula and continue filling the Perfusion Core.
10. Gently tap the Perfusion Core to dislodge any adhering air bubbles.
11. If required, unattach and reattach the side port caps to release any air bubbles trapped there.
12. Make all necessary connections to the Direct Perfusion Core that require priming.
13. Stop the pump when all the air bubbles have been removed.
14. Reattach 20 mL Damping Syringe as previously mentioned.

### NOTE:

The screw of the Universal Stand Clamp that holds the ring clamp of the Perfusion Core, can be loosened to allow twisting of the Perfusion Core to further aid the release of any trapped air bubbles.



## Chapter 4

# Electronics Setup

This chapter describes how to connect the electronic components of the Langendorff System, including the PowerLab and the transducers. References are also made to software installation and the connection of the electronics to the computer.

It is recommended that all electronic components be set up on a 'dry' table, separate to that used for the 'wet' Langendorff apparatus, Heated Water Recirculator and Peristaltic Pump.

# Water Heating

This Langendorff apparatus is designed to be compatible with a range of heated water bath recirculators. Please read the corresponding manual to identify and confirm the circulating inlet and outlet, and be familiar with its operation. Accordingly, set the heating temperature as desired, such as 37 °C.

# Perfusion

This section describes how to assemble the electronic components that are related to perfusion. The Langendorff apparatus may be perfused at a constant perfusion flow or a constant perfusion pressure using the STH Pump Controller. Otherwise, it can only be perfused at a constant perfusion flow with just a peristaltic pump.

## Peristaltic Pump

Several peristaltic pumps may be used with this Langendorff apparatus, such as the Minipuls 3 Peristaltic Pump. The Radnoti Pump Head and Peristaltic Pump Drive combination is described as an example.

**NOTE:**

The elastomeric insert that must be installed to reduce shaft wear and noise.

1. First ensure that the elastomeric insert is installed in the pump drive's shaft. Mount the Radnoti Pump Head (6 Roller) onto the Peristaltic Pump Drive (20-600 rpm, Dual Voltage) by aligning the pump head's shaft tang to the angle of the elastomeric insert (see Peristaltic Pump's documentation for more information). Make sure to align the two side protrusions next to the shaft to the corresponding alignment holes of the pump head, and that the pump head's lever is on top. An appropriate sized flat-bladed screwdriver may be required to assist alignment. Fasten the pump head via its two mounting bolt screws.
2. Ensure that the pump is not active and the rotors are not moving. Place the pump tubing with barbed luer adapters in the pump head by moving the lever left (towards opened lock symbol), loading in the tubing, and then moving the lever right (towards closed lock symbol) to clamp down on the tubing.

**Figure 4-1**

Changing pump lever to load and secure pump tubing



**Moving lever left to load Pump Tubing**



**Moving lever right to secure Pump Tubing**

## Peristaltic Pump Controller

The STH Pump Controller requires continuous detection and measurement of perfusion pressure, which can be measured using a pressure transducer and a Bridge Amp. In addition to providing feedback control of the Peristaltic Pump using the STH Pump Controller, this perfusion pressure signal can also be recorded as an experimental parameter.

PLEASE NOTE: Illustrations and descriptions are based on connecting to a PowerLab C via Front End Interfaces. Connections and connecting cables for Front Ends will vary when using previous PowerLab models.

**Figure 4-2**  
Setup of electronic components to control perfusion pressure and flow

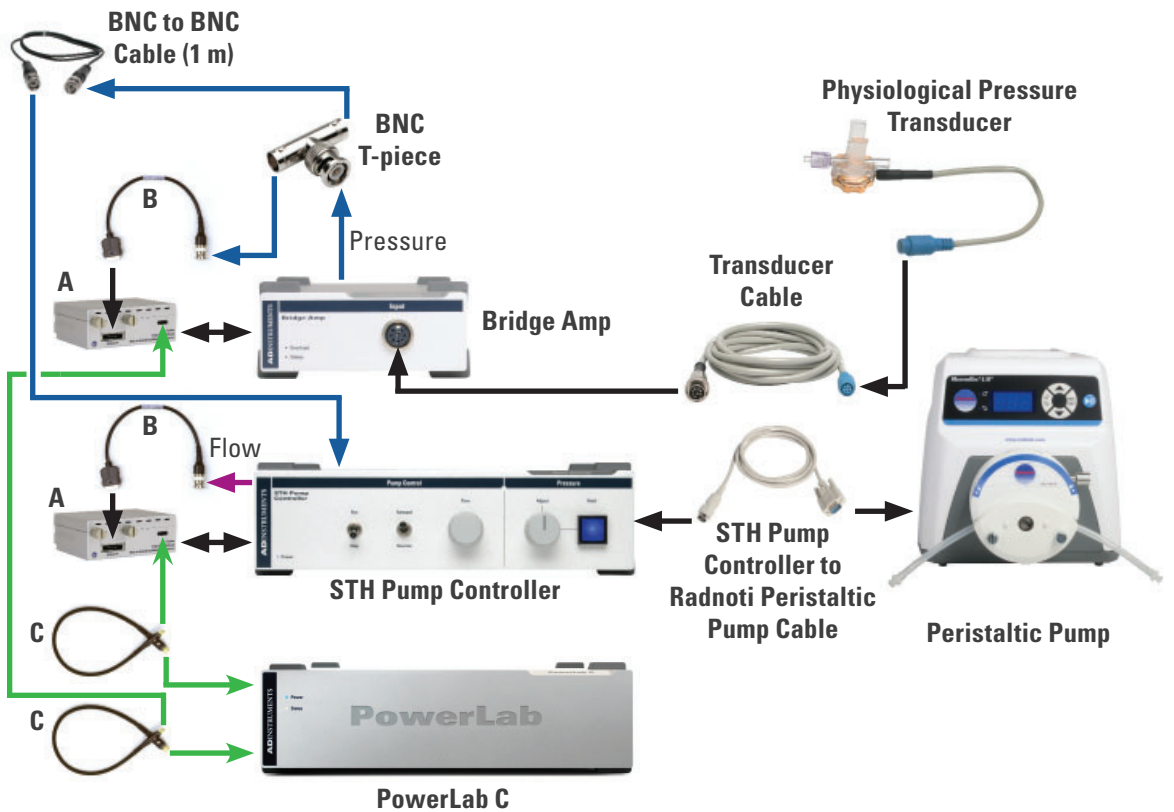

where

- A** - Front End Interface
- B** - Analog Cable for Front End Interface (1 Channel)
- C** - C Series USB-C to USB-C Cable (30 cm)



**NOTE:**

The PowerLab must be turned off before you connect or disconnect the STH Pump Controller or the Bridge Amp.

**NOTE:**

If a Quad Bridge Amp is used instead, connect the BNC T-piece to Output 1 at the rear of the Quad Bridge Amp. Use the first BNC connector of a Analog Cable for Front End Interface (4 Channel) for the perfusion pressure signal. Then sequentially connect the remaining BNC connectors to the rest of outputs at the rear of the Quad Bridge Amp, hence enabling their use.

1. Ensure that all electronic devices are turned off.
2. Position the Bridge Amp on the 'dry' table but conveniently close to the Peristaltic Pump.
3. Place the PowerLab C next to the Bridge Amp. If the setup requires two Bridge Amps, they can be placed side by side with the PowerLab C on top. Then the PowerLab C can be positioned on top of these two Bridge Amps. Similarly, if a Quad Bridge Amp is being used instead, position the PowerLab C on top (see Figure 4-9).
4. Place the STH Pump Controller on top of the PowerLab C.
5. Turn on the Peristaltic Pump and set its speed to the maximum before connecting it to the STH Pump Controller. Do not start pumping.
6. Connect the Peristaltic Pump to the STH Pump Controller using the STH Pump Controller to Radnoti Peristaltic Pump Cable, by attaching the DIN connector of the cable to the rear of the STH Pump Controller and the DB9 Serial Connector of the cable to the DB9 Serial Port at the rear of the pump.
7. Provide the STH Pump Controller with power and control by first attaching a Front End Interface to the I<sup>2</sup>C input on the rear of the STH Pump Controller. Ensure that the Front End Interface is firmly secured via its attaching screws. Next, connect the Front End Interface to a unused USB-C port of the PowerLab C via the C Series USB-C to USB-C Cable (30 cm).
8. Connect the BNC connector of the Analog Cable for Front End Interface (1 Channel) to the Flow Out BNC socket at the rear of the STH Pump Controller. Connect the plug at the other end of the Analog Cable, to the Analog I/O of the Front End Interface attached to the STH Pump Controller. Ensure that the plug firmly clicks into place. This provides the signal that can be used to derive the corresponding **perfusion flow signal**.
9. Similarly, attach a Front End Interface to the I<sup>2</sup>C input of the Bridge Amp and connect it to another unused USB-C port of the PowerLab C via and C Series USB-C to USB-C Cable (30 cm).
10. Connect the BNC T-piece to Signal Output at the rear of the Bridge Amp. This is used to split the **perfusion pressure signal**.
11. Connect the BNC connector of the Analog Cable for Front End Interface (1 Channel) to one end of the BNC T-piece and then connect its plug to the Analog I/O of the Front End Interface that has been connected to the Bridge Amp.
12. Use a BNC to BNC Cable (1 m) to connect the other side of the BNC T-piece to the Pressure In socket at the rear of the STH Pump Controller.
13. Connect the metal eight-pin DIN connector of the Transducer Cable to Input at the front of the first input of the Bridge Amp. Connect the blue connector of the Transducer Cable to the blue connector of the Physiological Pressure Transducer. There are several attaching options for a Physiological Pressure Transducer. Attach the pressure transducer as required by the experiment.

## Perfusion Pressure

The Stainless Steel Support Rods of the Langendorff apparatus can allow several attaching accessories to be mounted if required, including a Transducer Bracket for Physiological Pressure Transducer. This can support up to four Snap Holder for Physiological Pressure Transducer, which therefore provides flexibility when attaching the Physiological Pressure Transducer.

**Figure 4-3**

Mounting and attaching accessories for Physiological Pressure Transducer



**Transducer Bracket for Physiological Pressure Transducer**



**Snap Holder for Physiological Pressure Transducer**

There are several attachment options for the Physiological Pressure Transducer to measure perfusion pressure. Attach the Physiological Pressure Transducer to a side port of the Direct Perfusion Core (recommended) to provide a measurement closer to the cannulated heart. Additionally, it provides further insulation from natural fluctuations caused by the Peristaltic Pump. It can be connected directly either via a 3-Way Tap or tubing and a 3-Way Tap. If required, it can also be connected to the inlet of the Direct Perfusion Core, depending on the experimental requirements and protocol, such as running the experiments in constant perfusion flow only.

**Figure 4-4**

Several attaching options via a 3-Way Tap for the Physiological Pressure Transducer to measure perfusion pressure

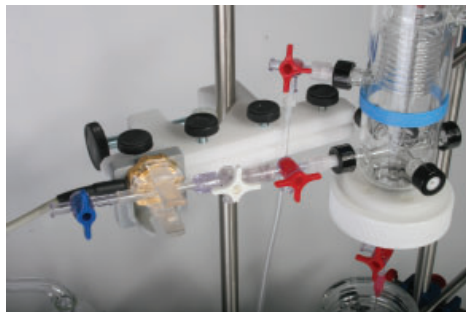

**Connecting directly to one of the Perfusion Core's side port with a Luer Port Coupler**



**Connecting to the inlet of Perfusion Core via tubing**

**NOTE:** **Left Ventricular Pressure**

Except for mice, several sizes of latex balloons and flexible balloon catheters, are available for purchase separately.

The Left Ventricular Pressure (LVP) of the isolated heart may be measured using a small isovolumic balloon and a balloon catheter. These are filled with fluid without any air bubbles, and are connected to a Physiological Pressure Transducer and Bridge Amp. An appropriate laboratory plunger syringe can be further intergrated into this assembly via a 3-Way Tap to allow inflation or deflation of the balloon. Some may prefer using a threaded plunger syringe (not supplied) to provide easier and precise control.

**Figure 4-5**

Setup of electronic components and options to measure left ventricular pressure

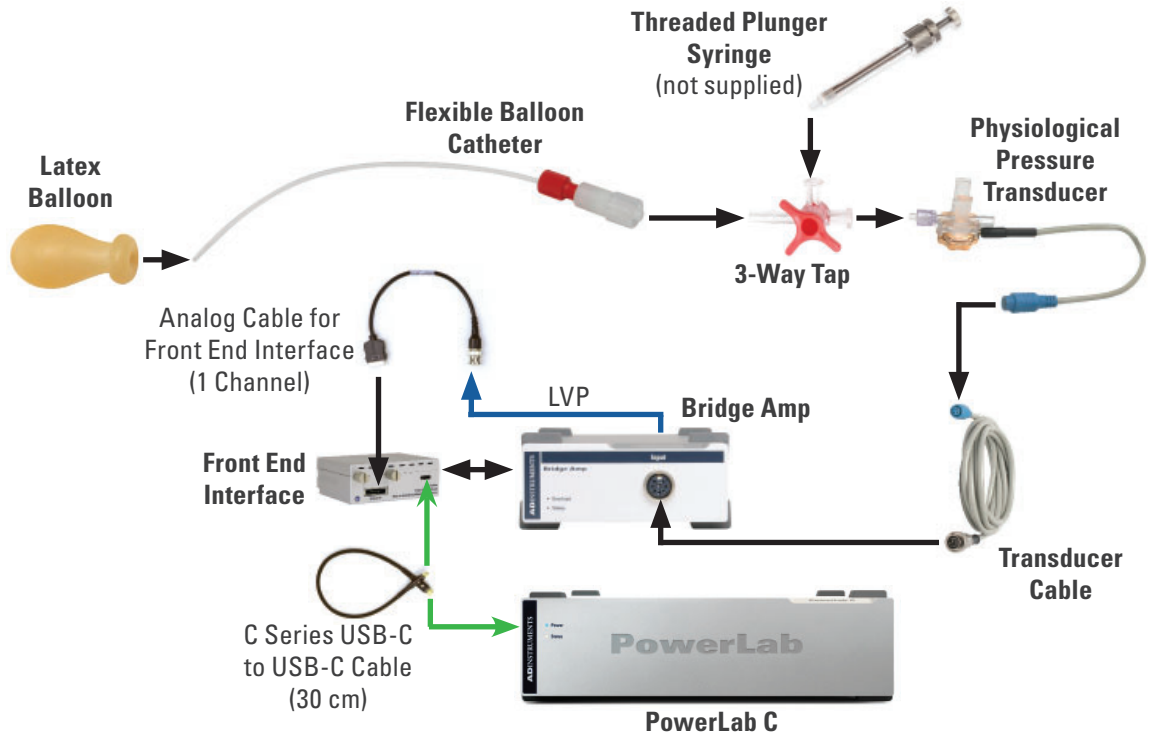

**NOTE:**

Non-absorbable surgical sutures (not supplied) are recommended to secure the Latex Balloon to the Flexible Balloon Catheter.

**NOTE:**

If a Quad Bridge Amp is used and its Output 1 has been already set up for perfusion pressure, ensure that its Output 2 is connected to the PowerLab. Then connect the DIN connector of the Transducer Cable to Input 2 at its front (see Figure 4-9).

1. Ensure that the Signal Output on the rear of the Bridge Amp is connected to a BNC connector of the Analog Cable for Front End Interface (1 Channel), which then connects to its Front End Interface and then PowerLab C. This represents the **LVP signal**.
2. Connect the metal eight-pin DIN connector of the Transducer Cable to Input at the front of the Bridge Amp.
3. Connect the blue connector of the Transducer Cable to the blue connector of the Physiological Pressure Transducer.
4. Similarly, the Snap Holder for Physiological Pressure Transducer and the Transducer Bracket for Physiological Pressure Transducer can be used to attach the Physiological Pressure Transducer to the nearest and appropriate Stainless Steel Support Rod. Attach the pressure transducer as required by the experiment.

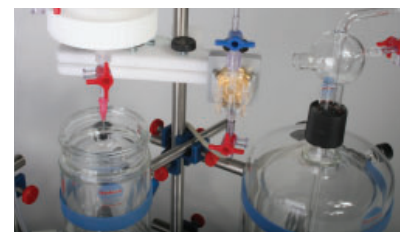

**Connecting the Physiological Pressure Transducer for LVP**

---

Usually the left atrium is first removed and the balloon catheter is then inserted while deflated, through the left atrioventricular opening. Next, the balloon is inflated to fill the entire volume within the left ventricle and kept constant. Therefore, the resulting pressure changes due to the contraction are measured by the Physiological Pressure Transducer and Bridge Amp, which is then recorded using the PowerLab. The volume of the balloon can then be adjusted to result in a small positive baseline pressure, which indicates no gaps between the balloon and the ventricular inner walls.

### **Apical Force Measurement (Optional)**

If required, the Radnoti Hi-Tech Heart Chamber (Small) also provides the option to perform an apical contractile force measurement via its supplied Apical Force Pulley Assembly. A suitable Force Transducer, Transducer Manipulator or Positioner, a shorter support rod of a suitable length and a Universal Stand Clamp (SSteel) will also be required.

1. Ensure that the large side port of the Hi-Tech Heart Chamber (Small) is uncapped and that the Apical Force Pulley Assembly is inserted through it with the pulley wheel facing upwards. Secure the pulley assembly by screwing on the large white drilled cap.
2. Attach one end of the shorter support rod to the Stainless Steel Support Rod via the Universal Stand Clamp (Stainless Steel).
3. Attach the Transducer Manipulator to the other end of the shorter support rod.
4. Connect the Force Transducer to another Bridge Amp. Ensure that its corresponding Output Signal at its rear is connected to a BNC connector of Analog Cable for Front End Interface (1 Channel), which is then connected to the Front End Interface that is attached to the Bridge Amp.
5. Connect the Front End Interface to an unused Input of the PowerLab C. This represents the **apical contractile force signal**.
6. Adjust the manipulator so that when the Force Transducer is attached, it is positioned near its adjustment range center.
7. Attach the Force Transducer to the manipulator, which should result in a force measurement in the horizontal direction.
8. Adjust and angle the Transducer Support Assembly and Force Transducer until the Force Transducer is in line with the Apical Force Pulley Assembly.
9. Rotate the Force Transducer to the vertical measurement position and calibrate with suitable fixed weights (not supplied). Rotate the Force Transducer back to its original horizontal measurement position after being calibrated.
10. Carefully thread the supplied Wire through the Apical Force Pulley Assembly ensuring that no kinks are created in the Wire.
11. Attach it to the apex of the heart after successful aortic cannulation. Surgical suture (not supplied) may also be used depending on the experimental protocol.
12. Adjust the Transducer Manipulator until the optimum pre-tension is reached, which is determined by the experimental protocol.

## Perfusate Temperature

The T-type Implantable Thermocouple Probe (IT-18) is an isolated probe totally sheathed in chemical resistant Teflon, which can be immersed in various solutions to measure temperatures up to 150 °C. Coupled with the flexibility of the Langendorff apparatus in providing a number of measurement sites, the temperature of the perfusate can be measured in a number of locations, including as it enters the heart. The thermocouple probe requires both a T-type Pod and a Pod Expander with a Front End Interface, to connect to PowerLab C.

1. Place the Pod Expander on top of the STH Pump Controller and connect the Front End Interface to the I<sup>2</sup>C input on the rear of the Pod Expander, Next connect this Front End Interface to a free USB-C port of the PowerLab C via the C Series USB-C to USB-C Cable (30 cm).
2. Connect all the BNC output at the rear of the Pod Expander to the Analog I/O of the Front End Interface that has been connected to the Pod Expander via an Analog Cable for Front End Interface (4 Channel). Ensure that the corresponding BNC connector of the Analog Cable number matches the BNC output.
3. Next, connect the cable of the T-type Pod into Input 1 on the front of the Pod Expander. Therefore, Output 1 of the Pod Expander provides the **temperature signal**. The T-type Pod should be positioned close to the Langendorff apparatus.
4. Connect the blue miniature flat-pin connector of the T-type Implantable Thermocouple Probe into the rear of the T-type Pod.
5. Fit the sensor of the T-type Implantable Thermocouple Probe into the desired location. For direct temperature measurements of the heart, the sensor can be first inserted through one of the four resealable openings in the Heart Chamber Lid. Then it can be extended down to be inserted into an unobtrusive location in the heart after the heart is successfully cannulated.

Figure 4-6

Setup of electronic components to measure temperature

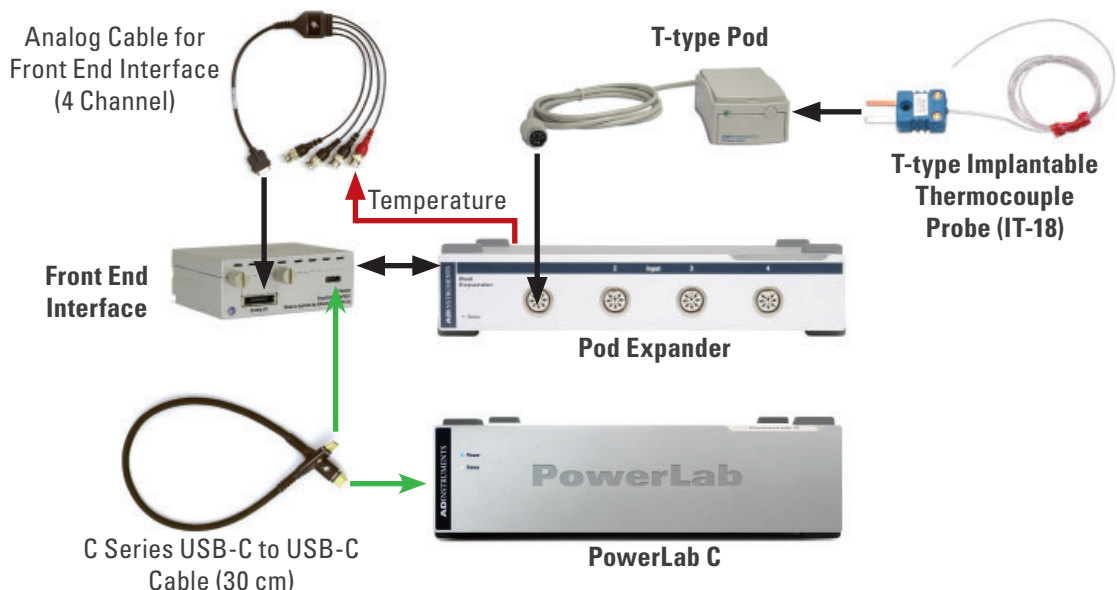





## Measuring pH, O<sub>2</sub> and CO<sub>2</sub> (Optional)

**NOTE:**

The Direct Perfusion Core has four side ports, which allow suitable ion selective (pH, carbon dioxide or CO<sub>2</sub> and oxygen or O<sub>2</sub>) microelectrodes to be inserted via a Rubber Port Coupler, hence making measurements very close to the cannulated heart. They measure dissolved ions in a Krebs buffer solution gassed with carbogen (95% O<sub>2</sub>/5% CO<sub>2</sub>) and include:

- Combination pH Microelectrode (Dip-Type, RGT)
- Carbon Dioxide Microelectrode (Dip-Type, RGT)
- Oxygen Microelectrode (Dip-Type, RGT)

**NOTE:**

Both the Combination pH Microelectrode and Carbon Dioxide Microelectrode require a Millivolt Adapter (DIN) each, while the Oxygen Microelectrode requires an O<sub>2</sub> Adapter (100, DIN) to connect each to an unused Input of the Pod Expander.

1. Select a free side port of the Direct Perfusion Core and attach a Rubber Port Coupler to it. Insert and secure the desired ion selective microelectrode to that side port.
2. Connect the LEMO connector of the microelectrode to the LEMO input port of its corresponding compatible adapter. The input port is marked as:
  - i. pH/ISE for the Millivolt Adapter (DIN) when using either the Combination pH Microelectrode or Carbon Dioxide Microelectrode
  - ii. INPUT for the O<sub>2</sub> Adapter (100, DIN) when using the Oxygen Microelectrode
3. Connect the LEMO Output port of the corresponding adapter to an unused Input of the Pod Expander (set up previously) via the supplied interconnecting DIN cable of the adapter. The BNC output of the Pod Expander provides either **pH, CO<sub>2</sub> or O<sub>2</sub> signal**, depending the connected microelectrode.

Additional Carbon Dioxide and Oxygen Membrane Kits are available for purchase.

O<sub>2</sub> Adapter (100, DIN) has reduced gain for measuring dissolved O<sub>2</sub> in solutions with high concentration of dissolved O<sub>2</sub>.

**Figure 4–8**

Setup example of electronic components to measure pH, dissolved carbon dioxide and oxygen

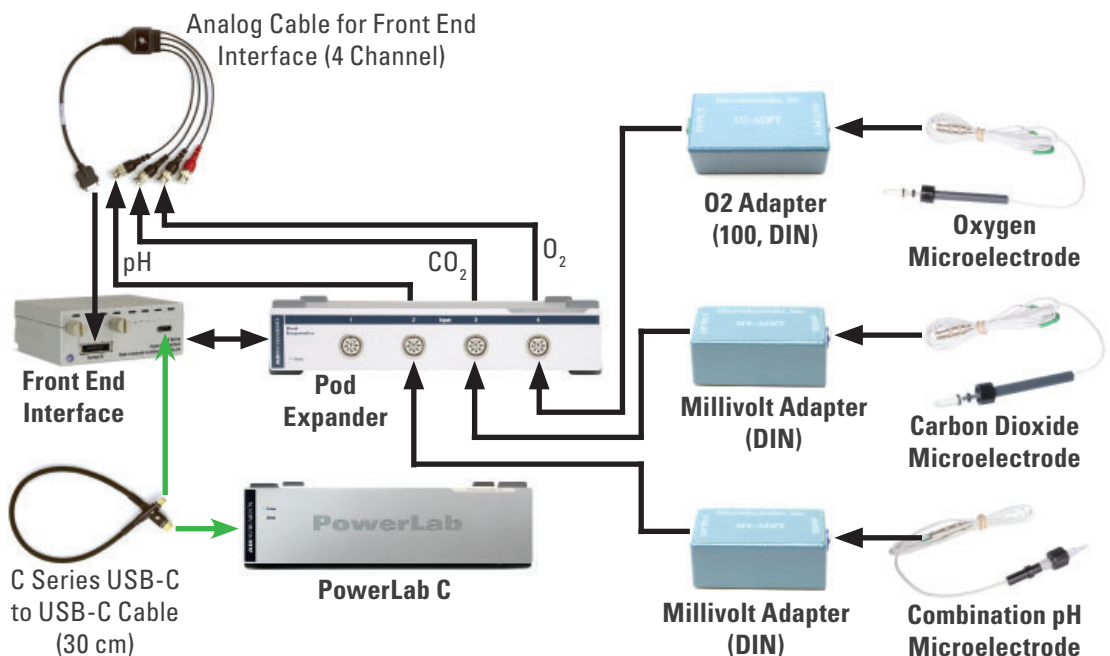



---

# Software Installation

LabChart software should be installed on the computer before connecting the PowerLab to the computer.

## **LabChart 8**

The installation is described in the *Getting Started with LabChart* that is available as a booklet supplied with the software. The pdf file version is also available for download from <https://www.adinstruments.com/support/manuals>.

## **LabChart Lightning**

The appropriate software version can be downloaded from <https://licensing.labchart.com/>. Execute the file to start the ADInstruments LabChart Lightning Setup Wizard and follow the steps to complete the installation. Getting started and support videos are available from <https://www.adinstruments.com/support/labchart-lightning>.

# Connecting the PowerLab to the Computer

The PowerLab must be connected to the computer before the setup of the electronic components can be tested. Depending on the PowerLab model, the connection of the PowerLab to a computer is described in the *PowerLab Owner's Guide* or in pdf file version that is available for download from <https://www.adinstruments.com/support/manuals>. Ensure that the corresponding connection methodology matches the model of PowerLab that will be used.

**Figure 4-9**

Example of a setup with single reservoir Langendorff apparatus, Heated Water Recirculator, Peristaltic Pump, PowerLab C (A), Quad Bridge Amp (B), STH Pump Controller (C), Pod Expander (D), Bio Amp (E), and T-type Pod (F)

**NOTE:**

Physiological Pressure Transducers, sensors and electrodes are not shown.

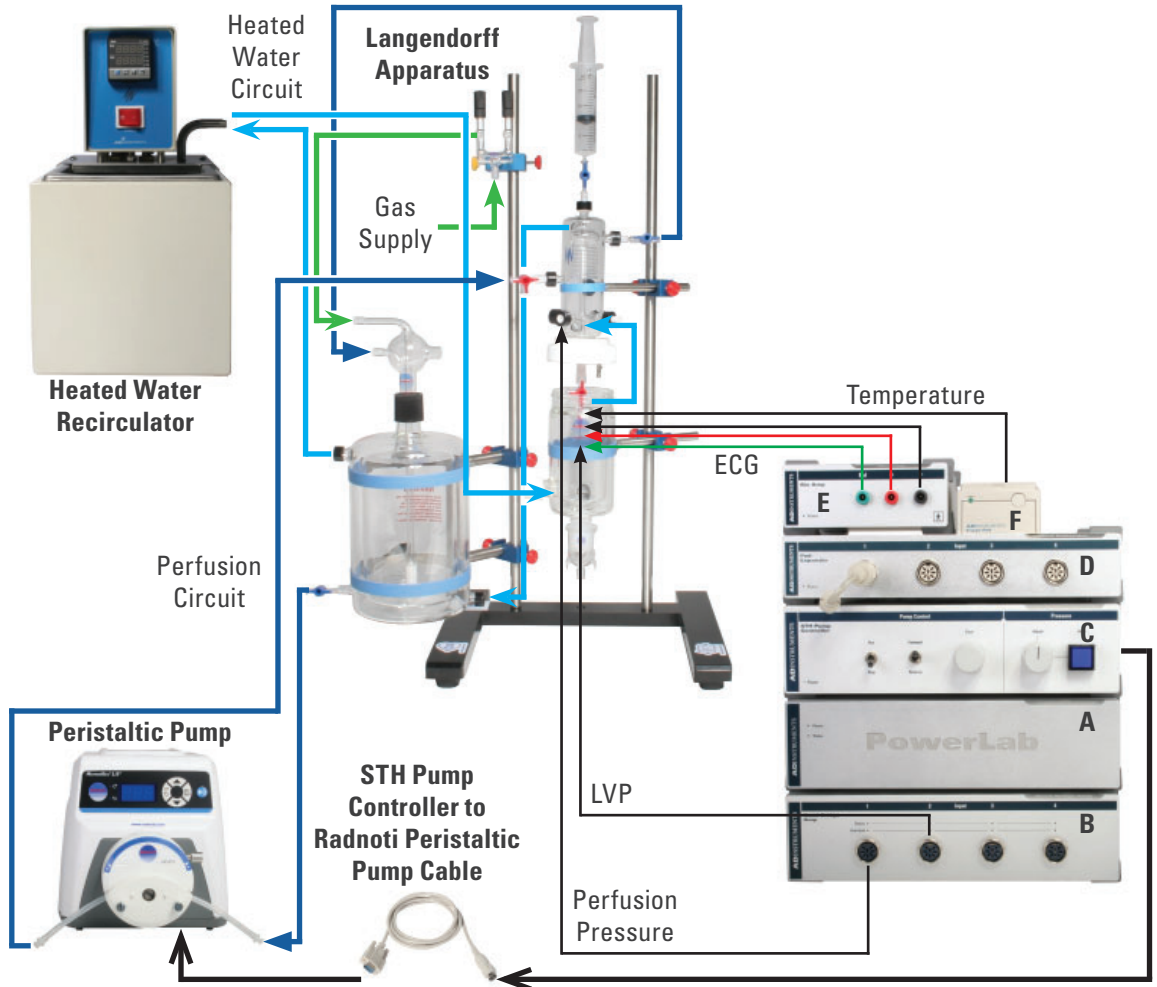



## Chapter 5

# Calibration and Testing

This chapter describes the calibration and testing procedures for the completed Langendorff System setup.

It includes the basic testing and necessary calibrations for each of the components and selecting the appropriate software settings. Procedures for calibrating both the perfusate pressure and flow signals are described, which include testing the correct operation of both the constant flow and constant pressure modes of the Langendorff System. Further information on each hardware component may be available in their own documentation.

Brief hints for setting up a perfused heart are also offered.

---

# Testing the Electronics

The electronic components can be tested once the LabChart software is installed and the PowerLab is connected to your computer.

## Power Up Self-test with LabChart 8

With the electronic components connected as described above, and before the LabChart software is running, the following should be observed when the PowerLab is switched on:

- The Power indicator light on the front panel of the PowerLab should glow blue
- The Status indicator light of the PowerLab should glow green
- The Power indicator light of the STH Pump Controller should glow green
- The Status indicator light of the T-type Pod should glow green.

Now, with the PowerLab turned on, start the LabChart software on the computer. The following should be observed:

- The Status indicator lights of the Bridge Amps, Bio Amp and Pod Expander should all flash a number of times and then glow green, showing that the software has found the front-ends, has checked them, and is ready to use them. If the indicator lights fail to flash, then check the I<sup>2</sup>C connections. If the indicator lights flash, but fail to stay on, check the BNC connections.
- The Input Amplifier name in each Channel Function pop-up menu and in the Channel Settings... dialog is replaced by the name of the corresponding connected hardware. As an example, if Channel 1, is set up to record perfusion pressure with the Bridge Amplifier, the Channel Function pop-up menu should have a Bridge Amplifier as its name. Similarly, the electrical activity will have Bio Amplifier, and the perfusate temperature will have T-type Pod.

## Power Up Self-test with LabChart Lightning

Similarly, before the LabChart Lightning software is running, the following should be observed when the PowerLab is switched on:

- The Power indicator light on the front panel of the PowerLab should glow blue.
- The Status indicator light of the PowerLab should glow green

Now, with the PowerLab turned on, start the LabChart Lightning software. Ensure all electronic components are properly identified and added via the Devices pop-menu in Chart View (see Figure 5-1). The following should be observed:

- The Power indicator light of the STH Pump Controller should glow green
- The Status indicator light of the T-type Pod should glow green.
- The Status indicator lights of the Bridge Amps, Bio Amp, Pod Expander and T-Type Pod should glow green.
- The corresponding number of Signals will appear in Chart View with the name of corresponding connected hardware. As an example, if Channel 1, is set up to record perfusion pressure with the Bridge Amp, the Signal pop-up menu should have a Bridge Amp 1 as its name. Similarly, the electrical activity will have Bio Amp, and the perfusate temperature will have T-type Pod.

### NOTE:

Check the connections of the electronic components if they failed to be identified in LabChart Lightning or their indicator lights do not turn on.

Figure 5-1

LabChart Lightning's pop-up menus: Devices (top left and right) and Sampling Signal Settings in Chart View (bottom).

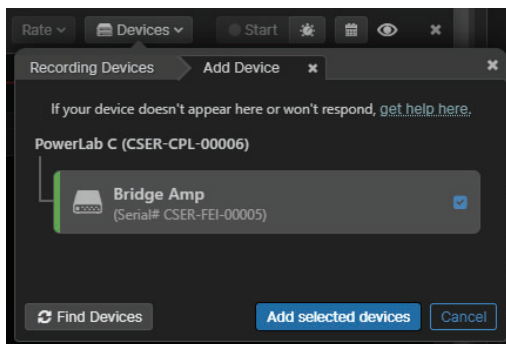

Identifying and adding devices via Devices pop-up menu

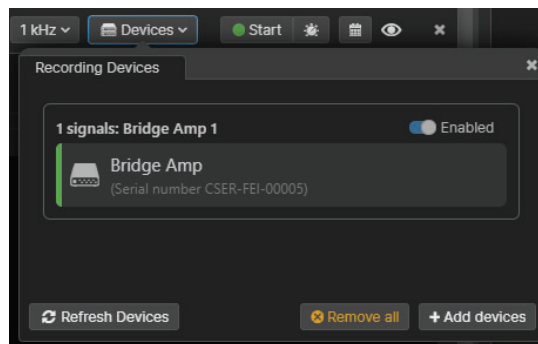

Added devices in Devices pop-up menu

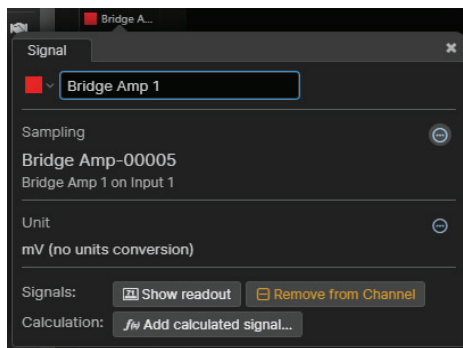

Named Signal pop-up menu

## Testing the STH Pump Controller

If these above checks are OK, then you can perform a quick check of the STH Pump Controller. With the apparatus and electronic components setup, and with the PowerLab switched on and LabChart running, check the STH Pump Controller as follows:

**NOTE:**

Signals displayed in Channels 1 and 2 of the Chart View will have units of Volts.

This is because these have not yet been calibrated or had units conversions applied.

1. Click the Start button in LabChart to begin sampling.
2. Start the Peristaltic Pump using the Run/Stop switch on the front panel of the STH Pump Controller.
3. Use the Forward/Reverse switch on the STH Pump Controller to change the pump direction of rotation. Forwards is clockwise.
4. Use the Set Flow knob on the STH Pump Controller to alter the pump speed. You should observe that the pump speed displayed on the front of the pump changes, and that the flow rate displayed in Channel 2 of the Chart View also changes. If the perfusion pressure transducer is connected and if the perfusate circuits have been primed then you should also observe changes in the pressure signal displayed in Channel 1 of the Chart View.

## STH Pump Controller Pressure Gain Adjustment

The STH Pump Controller is factory calibrated for use with ADInstruments Bridge Amplifiers. If third party equipment is being used, a pressure gain adjustment on the STH Pump Controller is required for the first time that it is being used. The procedure for doing this is described in the *STH Pump Controller Owner's Guide*.

---

# Calibration

After having performed the basic checks to confirm the correct setup of the electronics and the perfusion pressure transducer, you can now calibrate the perfusion pressure and flow signals.

## Perfusion Pressure Calibration

To calibrate the perfusion pressure transducer you need a way to apply pressure to the transducer, such as with a rubber bulb or syringe, and a pressure measuring device such as a sphygmomanometer. Ensure that the apparatus is fully primed and the pressure transducer is filled with clean buffer.

1. Attach the sphygmomanometer to the 4-way stopcock at the dome, and the syringe to the 4-way stopcock connected to the dome at the junction block. Set the stopcocks so that the dome is isolated from the circuit and open to the manometer and syringe.
2. With the PowerLab switched on, open LabChart.
3. Open the Bridge Amplifier dialog for Channel 1 from the Channel Function pop-up menu (LabChart 8), or the Signal Sampling Settings dialog from the Bridge Amp pop-menu in Chart View (LabChart Lightning), see Figure 5-2. Set the range to 10 mV. Open the 4-way stopcock at the dome to air, and zero the Bridge Amp. Close the 4-way stopcock. Set filtering as required. Click **OK** (LabChart 8) or **Apply** (LabChart Lightning) to apply the changes and close the dialog.
4. Start recording in LabChart.
5. Use the syringe to produce a pressure reading of 150 mmHg on the sphygmomanometer. Use a pressure similar to the working pressure of your experiments. Maintain a constant pressure with the syringe long enough to obtain several seconds of constant pressure in the LabChart recording.
6. Now set the stopcock at the junction block so as to isolate the syringe from the dome while opening the dome to the perfusate reservoir. A stepped waveform should be produced in LabChart. After several more seconds stop LabChart.
7. Select the step portion of the waveform and open the Units Conversion dialog from the Channel Function pop-up menu (LabChart 8) or from the Bridge Amp Signal pop-up menu (LabChart Lightning). In the **Units** pop-up menu choose **mmHg**.
8. Use the sampled values to perform a two-point calibration:
  - i. Select a portion of the lower region of the step and click the arrow button to enter a value for **Point 1**. This represents 0 mmHg, so enter that in the right-hand text box for **Point 1**.
  - ii. Now select from the higher region of the step, and click the arrow button for **Point 2**. This represents the pressure you measured with the sphygmomanometer, so enter that value (150 mmHg) in the right-hand text box for **Point 2**.
  - iii. Click **OK** (LabChart 8) or **Apply** (LabChart Lightning) to apply the conversion and close the dialog.

- Set the stopcocks so that the sphygmomanometer and syringe are isolated from the circuit, and disconnect them.

**Figure 5–2** **LabChart 8**

Setting up and calibrating the perfusion pressure channel in LabChart 8 and LabChart Lightning software.

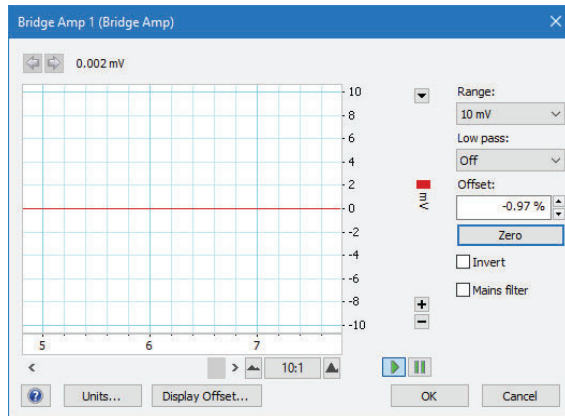

Zeroing, setting the range and filter options in Bridge Amp dialog

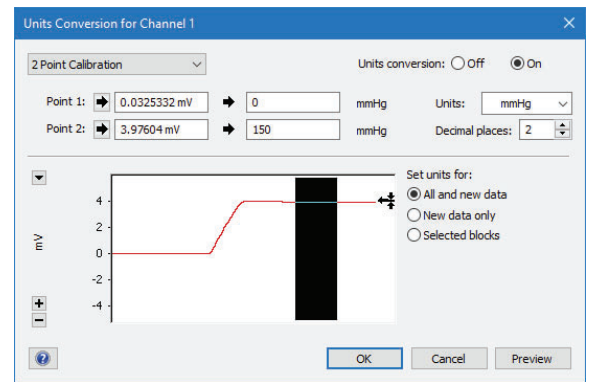

Matching corresponding recorded signal amplitudes to known pressures in Units Conversion dialog

### LabChart Lightning

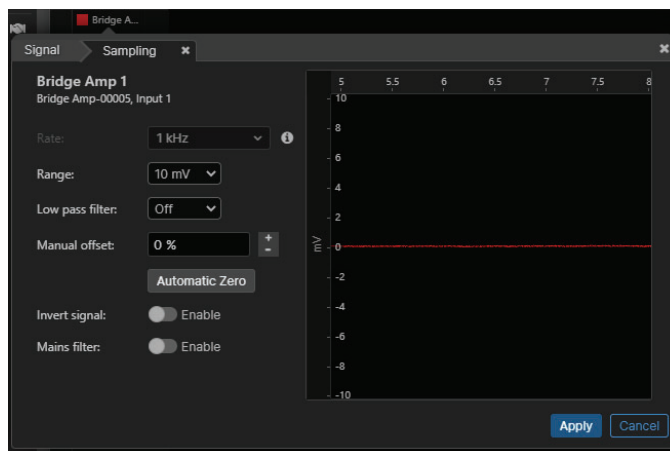

Zeroing, setting the range and filter options in Signal Sampling Settings dialog

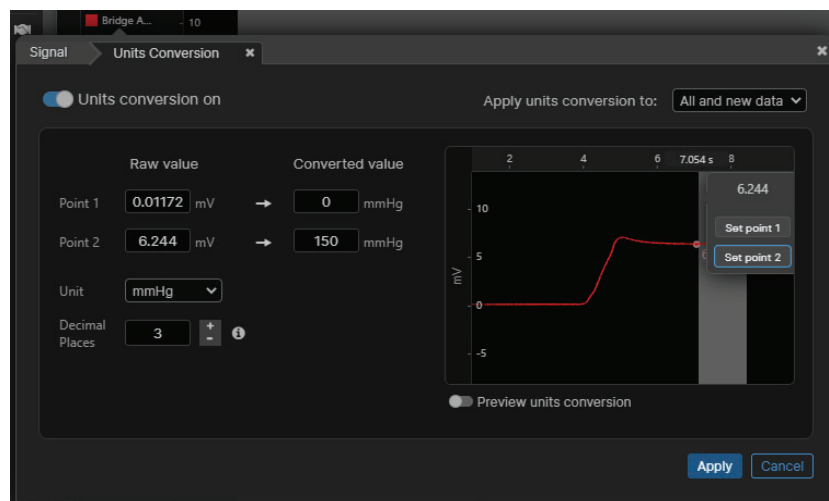

Matching corresponding recorded signal amplitudes to known pressures in Units Conversion dialog



---

## Flow Calibration

### NOTE:

The flow rate depends on the internal diameter of the peristaltic tubing fitted to the pump. You need to calibrate the pump using the size of tubing that will be used in the experiments.

In order to calibrate the flow signal from the STH Pump Controller we need to determine the volume delivered by the pump per unit time at a typical working pump speed.

The procedure described below uses LabChart to measure a predetermined time (2 minutes, for example) during which the perfusate delivered by the pump is collected and the volume measured. Other methods of measuring the time taken and the volume delivered are just as suitable.

It is best to calibrate the peristaltic pump with it running at about the same speed as will be used in experiments. The procedure below will calibrate at a flow of about 5 mL/min, which is typical for a mouse heart.

Calibrate the pump flow as follows:

1. Ensure that the appropriate sized aortic cannula is attached. A similar sized inner diameter tubing can be fitted to the cannula. Arrange for the perfusate outflow from the tubing to be delivered into a measuring cylinder.
2. Set the 3-Way and 1-Way Taps so that only one perfusate circuit is open to the cannula.
3. Switch on the PowerLab and start LabChart. Open a new document. Set the range of the selected Channel that is recording flow to 10 V.
4. Switch on the peristaltic pump using the switch at the rear. Note that the pump should have been set manually to its maximum speed using the ▲ button before the controller cable was attached. (The pump treats the control signal from the STH Pump Controller as being a proportion of the speed set at the pump.)
5. Start the pump with the Run switch on the STH Pump Controller. Use the Set Flow knob on the STH Pump Controller to run the pump at the maximal speed expected to be required for experiments.
6. Start sampling with LabChart. Add a comment in flow Channel to indicate the moment at which you direct the perfusate outflow into the measuring cylinder.
7. Once the predetermined period of time has elapsed (for example, 2 minutes), add a comment to that Channel and immediately direct the perfusate outflow away from the measuring cylinder. Then after a few seconds, stop the LabChart recording and the pump.
8. Determine the volume of perfusate that was delivered into the measuring cylinder.
9. Calculate the volume delivered per unit time, in mL/min.
10. Set up Units Conversion in the flow Channel (see Figure 5-3) as follows:
  - i. Select the step in the flow signal in the Channel and open the Units Conversion dialog from the channel pop-up menu.
  - ii. Choose **mL/min** from the **Units** pop-up menu.

- iv. Select a portion of the lower region of the step and click the arrow button to enter a value for **Point 1**. This represents 0 mL/min so enter 0 in the right-hand text box for **Point 1**.

Figure 5-3

LabChart 8

The Units Conversion dialog for the flow channel, with the higher region of the step selected.

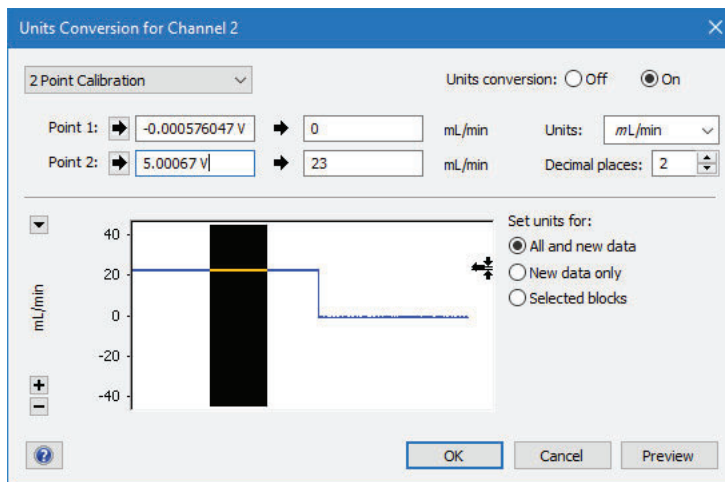

Matching corresponding recorded signal amplitudes to calculated flow rates in Units Conversion dialog

LabChart Lightning

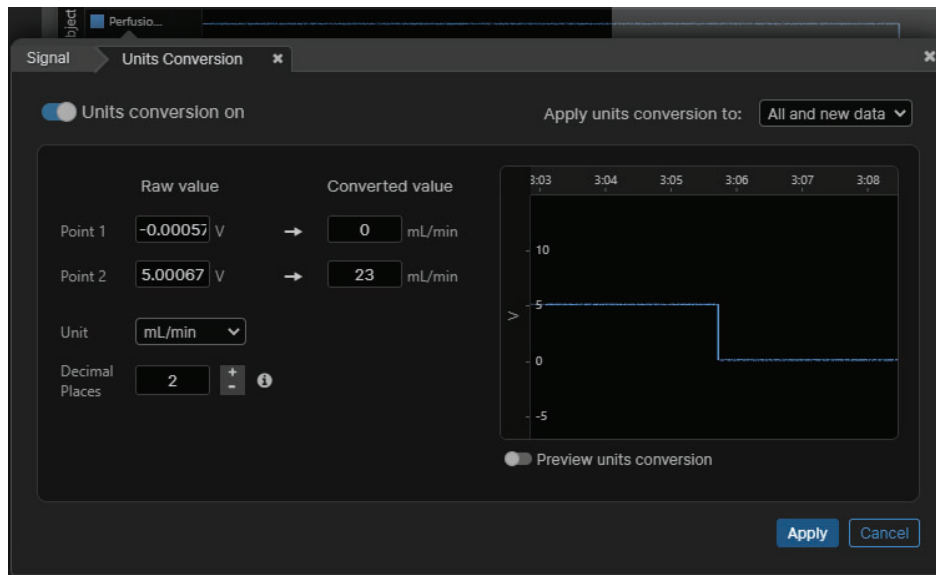

Matching corresponding recorded signal amplitudes to calculated flow rates in Units Conversion dialog

---

## Testing the Langendorff System

You can now test the complete Langendorff System, to demonstrate that both the constant flow and constant pressure modes of operation are working correctly:

### NOTE:

If a fine-bore tubing is unavailable, a 3-Way Tap spliced in between or a finger can be used to partially occlude the outflow to increase the pressure. Care is required not to overpressure the circuit.

1. The apparatus and electronics should be set up as previously described.
2. The perfusion circuits and perfusion transducer line should be primed and the pressure line damping syringe should be in position, as described.
3. Attach fine-bore tubing to the cannula, in order to provide some resistance.
4. Set the 3-Way and 1-Way Taps so that one perfusate circuit is open to the cannula. Ensure that the pressure transducer line for measuring perfusion pressure is also open to this circuit. Ensure all other unused ports are sealed.
5. Turn on the PowerLab and start LabChart.
6. Set up LabChart with the appropriate sampling rates as required by the experiment.
7. Turn the Set Flow knob on the STH Pump Controller to zero (fully anti-clockwise) and ensure that the Adjust knob is centered.
8. Switch the STH Pump Controller to Run and start sampling in LabChart. Use the Set Flow knob to adjust the flow to a suitable rate (about 5 full turns clockwise) which still allows the flow to be adjusted either way.

Checking the **constant perfusion flow** mode of operation as follows:

1. Raising the other end of the tubing that is not attached to the cannula should result in an increase in the pressure signal displayed by LabChart, as a result of the increased head of pressure in the circuit. Similarly, lowering the outlet should result in a decrease in the pressure signal. In both cases the flow should remain constant.

Checking the **constant perfusion pressure mode** of operation as follows:

1. With the PowerLab on and LabChart sampling as above, and with the outlet of the tubing attached to the cannula near the level of the heart chamber, adjust the speed of the pump to achieve the pressure you wish to clamp at (for example 80 mmHg).
2. Once the pressure signal has stabilized, press the Hold button on the STH Pump Controller. When this is illuminated the Pump Controller continuously adjusts the pump speed in order to maintain constant pressure in the perfusion circuit.
3. Use the Adjust knob to correct any initial undershoot or overshoot of the target pressure.
4. Raise the outlet of the tubing attached to the cannula by a few centimeters. This increases the head of pressure in the circuit. You should observe that the pump slows down in order to maintain the target pressure, which should not vary.
5. Lower the outlet of the tubing attached to the cannula by a few centimeters. This decreases the head of pressure in the circuit. You should observe that the pump speeds up in order to maintain the target pressure, which should not vary.

- 
6. Pressing the Hold button again causes the light to go out and returns the system to constant flow mode.

## Setting Up an Isolated Perfused Heart

Once the assembly and calibration of the Langendorff System has been completed you can mount a heart for perfusion.

The following suggestions are offered:

- Use an appropriate germicide in the Heated Water Recirculator to reduce cleaning requirements.
- Allow sufficient time after starting the Heated Water Recirculator for the temperature of the system to equilibrate.
- Allow sufficient time in gassing the perfusate buffer to reach the required pH
- Prime the perfusion circuit and ensuring no air bubble present.
- Run warmed perfusate through the cannula for several minutes just before cannulating the aorta. This raises the temperature of the cannula to avoid thermal shock to the heart.
- Run the peristaltic pump slowly in constant flow mode when cannulating the aorta.
- The perfusion flow can be adjusted with the Set Flow knob on the STH Pump Controller after the heart is mounted on the cannula.

## Troubleshooting a Rapidly Failing Heart

The isolated heart preparation is normally very stable and reproducible once familiarity with it has been gained. A rapid deterioration unexpectedly occurring in two preparations consecutively is a strong indication of a problem. Usually this failure is due to the growth of bacteria and the release of endotoxins into the perfusate. Initial corrective measures should include:

- A thorough cleaning of the apparatus and replacement of tubing/fittings and replacement of solutions (which have a limited storage life in the refrigerator).
- Tubing should be thoroughly pre-rinsed to remove plasticizers and the use of a high-quality silicone or Tygon tubing is recommended.
- Check the water source. The use of high quality water is essential. Some experimenters use small amounts of EDTA (0.1 mM) to chelate trace heavy metals in suspect water supplies, although this is less of a problem with modern multiple cartridge ion-exchange systems.
- A check that the appropriate gas mixture and resultant pH of the aerated buffer is achieved at the normal operating temperature.
- Records should be kept of new purchases of substrate and salts. Certain toxic agents used may be difficult to clean from the system and may require the use of organic solvents or the removal of tubing after each use, as well as the use of a separate reservoir.

### NOTE:

Silicone tubing is extremely gas permeable; oxygen and other gas losses can be considerable.



## Chapter 6

# Cleaning

This chapter describes the cleaning and maintenance of the Langendorff System.

---

# Cleaning

After the experiment has been completed, care should be taken to scrupulously clean the equipment. It is important to remember that the solutions that can sustain the heart and muscle will also provide excellent media for bacteria.

The cleaning procedures will be dependent upon:

- types of chemicals and biological materials that are being used.
- types of measurements that are being made and what substances can interfere with those measurements.
- frequency of use of the equipment and number of users involved.

## General Cleaning Tips

### NOTE:

- Non-phosphate soaps are preferred since insoluble phosphates can form from calcium and magnesium in physiological salt solutions.
- Cleaning supplies and equipment (such as brushes) should be used only for cleaning this glassware and not used for other lab cleaning procedures.
- Often overlooked as a source of contamination is the water supply. This should be kept clean, the bath rinsed, and solution changed to reduce precipitate build up.
- Covering equipment to reduce airborne contamination from microbes and spores is useful.
- A convenient rule of thumb for testing for contamination in preparations that you have found reliable is that two consecutive experimental failures that are not explained by an obviously damaged sample, poor surgical or dissection techniques, or solution problems may be caused by perfusate contamination.

Shared equipment is the most difficult to maintain properly. In order to maintain equipment properly it is generally best to:

- assign the maintenance or the oversight of the equipment to one individual who will monitor equipment and maintain cleaning supplies.
- have written protocols posted with the equipment.
- have a logbook where cleaning dates, as well as notification of problems, suggestions, etc., can be recorded.

Bactericidal soaps may contain iodine or other materials which can affect isolated tissues and cells.

---

## Cleaning Glass Items

- The glassware is borosilicate glass, which can be cleaned with a wide range of soaps, ethyl alcohol, dilute HCl or HNO<sub>3</sub> (0.1 M) or other solvents.
- Extensive flushing with distilled, deionized water to remove all traces of the cleaning agents and salts is recommended. Large glassware, such as reservoirs or assemblies can be flushed in place, but care must be taken to thoroughly clean aerators, stopcocks and associated parts.
- Aerators should be blown dry using gas or air at the final water rinse. If acid is used, the runoff water should not be more acidic than the normal water pH.
- As with the use of any chemicals, proper protective gear and training are essential to reduce personnel hazards and experimental and environmental contamination.
- Heated acid or chromic acid is generally not recommended due to personnel hazards and possible heavy metal contamination of the system.
- If very lipophilic substances (prostaglandins, ionophores, certain dyes, etc.) are used, rinses with ethyl alcohol or the most appropriate organic solvent can be used first, but this will necessitate thorough cleaning afterward to remove any traces of the organic solvent.
- Use of toxins, biohazard materials, and radiochemicals can present considerable complications to a generalized cleaning procedure. Having an apparatus and a contained area dedicated to these procedures reduces problems.
- Diluted bleach can be used on glassware but must be rinsed extensively.
- Glassware can be sterilized but all fixtures (such as aerators, stopcocks caps, etc.) should be removed prior to sterilization.
- The glass aerators can be cleaned with water or dilute acid if clogged.
- The use of water or gas under high pressure can result in damage to the glassware and personnel and therefore is not recommended.
- After a general soap and water rinse to remove soluble materials, cleaning with 0.1 M HCl or 0.1 M HNO<sub>3</sub> for several hours or overnight, followed by an extensive water rinse, will usually remove most contaminants. If this does not work, 1 M acid can be tried. Again, if acid is used, the runoff water should not be more acidic than the normal water pH.
- Because the glass frit filaments are thin, high concentrations of acids, or especially alkalis, can destroy them and are not recommended.



---

## Cleaning Non-Glass Items

- Initial cleaning of non-glass items should be with aqueous soap solutions. Depending upon the chemical resistance of the materials, the use of other solvents, cleaning procedures or sterilization may be possible.
- Areas and items to be especially well cleaned are the aerator, tubing, syringe ports, cannulae, pressure transducer fittings, septa, balloon, catheters, and electrodes (oxygen, pacing, ion selective, etc.).

## Tubing Maintenance

### NOTE:

Silicone tubing is very permeant to gases, so it should not be generally used to transport gassed solutions.

Tubing should be inspected at the pump head for wear. The interior of tubing can gradually be roughened during use and the abraded areas will form sites for bacterial growth. Tubing should be a high grade with low plasticizer leaching.

The use of disposable tubing and stopcocks will assist in cleanup, as will regular scheduling of these procedures, rather than intermittent experiments, if non-dedicated equipment must be used. When baths are used intermittently the lack of frequent cleaning and the lack of solutions rinsing out bacteria that are deposited in the tubing may result in a contamination problem when the system is finally used.



# Warranty

## **Product Purchase and License Agreement**

This Agreement is between ADI Instruments NZ Ltd [‘ADI’] and the purchaser [‘the Purchaser’] of any ADI product or solution — software, hardware or both — and covers all obligations and liabilities on the part of ADI, the Purchaser, and other users of the product. The Purchaser (or any user) accepts the terms of this Agreement by using the product or solution. Any changes to this Agreement must be recorded in writing and have ADI’s and the Purchaser’s consent.

## **Responsibilities**

The Purchaser and any others using any ADI product or solution agree to use it in a sensible manner for purposes for which it is suited, and agree to take responsibility for their actions and the results of their actions. If problems arise with an ADI product, ADI will make all reasonable efforts to rectify them. This service may incur a charge, depending on the nature of the problems, and is subject to the other conditions in this Agreement. ADI does not separately warrant the performance of products, equipment or software manufactured by third parties which may be provided to Purchaser as part of an overall solution. However, as further noted below, ADI will pass through to Purchaser all applicable third party warranties to the extent it has the right to do so.

## **ADI Product Hardware Warranty**

ADI warrants that PowerLab Data Acquisition Units (PL prefix)<sup>1</sup> and Front-ends (FEprefix)<sup>2</sup> shall be free from defects in materials and workmanship for five (5) years from the date of purchase. Other PowerLab Data Acquisition Units<sup>3</sup>, Front-ends<sup>4</sup> and Pods<sup>5</sup> shall be free of defects in material and workmanship for three (3) years from their date of purchase. ADI also warrants that ADI Specialized Data Recorders<sup>6</sup> and Instruments<sup>7</sup> shall be free of defects in material and workmanship for one (1) year from their date of purchase. If there is such a defect, as Purchaser’s sole remedy hereunder, ADI will repair or replace the equipment as appropriate, and the duration of the warranty shall be extended by the length of time needed for repair or replacement.

To obtain service under this warranty, the Purchaser must notify the nearest ADI office, or Authorized Representative, of the defect before the warranty expires. The ADI or Representative office will advise the Purchaser of the nearest service center address to which the Purchaser must ship the defective product at his or her own expense. The product should be packed safely, preferably in its original packaging. ADI will pay return shipping costs.

---

## Hardware Warranty Limitations

This warranty applies only to the ADI hardware specified in this document and used under normal operating conditions and within specification. Consumables, electrodes and accessories are not covered by this warranty. Third party equipment may be covered by the third party manufacturer's warranty. To the extent that ADI has the right to pass through any third party manufacturer warranties to Purchaser it will do so to the extent it is able to do so. Copies of applicable third party manufacturer warranties, to the extent they exist, are available upon request. The warranty provided hereunder does not cover hardware modified in any way, subjected to unusual physical, electrical or environmental stress, used with incorrectly wired or substandard connectors or cables, or with the original identification marks altered. Tampering with or breaking of the Warranty Seal will also void the warranty.

## Product Types & Warranty Term

### ADI manufactured products covered by a five (5) year warranty

<sup>1</sup> Data Acquisition Units: PowerLab C, C Series devices & 35 series with PL prefix

<sup>2</sup> Front-ends: ADI Front-end Signal Conditioners with FE prefix.

### ADI manufactured products covered by three (3) year warranty

<sup>3</sup> Data Acquisition Units: PowerLab 26 series with ML prefix

<sup>4</sup> Front-ends: ADI Front-end Signal Conditioners with ML prefix.

<sup>5</sup> Pods: The entire range of ADI Pod Signal Conditioners.

### ADI manufactured products covered by one (1) year warranty

<sup>6</sup> Specialized Data Recorders: Metabolic Systems (e.g., ML240 PowerLab/8M Metabolic System)

<sup>7</sup> Instruments: Blood FlowMeter, Gas Analyzers, NIBP System (excluding transducers), STH Pump Controller.

### Third Party Products (Including Transducers)

Products not manufactured by ADI are covered by the manufacturer's warranty.

### Accessories and Consumables

Accessories and Consumables are not covered by any type of warranty.

## General Limitations

ADI products are produced to high standards, and should perform as described in the supplied documentation. There is a limited hardware warranty, and technical support is provided for all ADI products. Nevertheless, since ADI products could be affected by external factors (for instance, the computer system on which they run and other hardware and/or software provided by third parties), absolute performance and reliability of products and the overall solution cannot be guaranteed. No warranty, either expressed or implied or statutory, other than that expressly contained in this Agreement, is made in respect to ADI products or software, third party products or software, the overall solution or otherwise. The Purchaser therefore assumes all risks as to the performance and reliability of the products, the software, the solution and the results gained using them. ADI neither assumes or authorizes any person to assume on its behalf any liability in connection with the sale, installation, service or use of its products. ADI shall not be held responsible for special, consequential or punitive damages of any kind aris-

---

ing out of sale, installation service or use of its products.

EXCEPT FOR THE EXPRESS WARRANTY SET FORTH HEREIN, THE SOLUTION AS WELL AS ALL EQUIPMENT AND SOFTWARE PROVIDED HEREUNDER ARE PROVIDED “AS IS” AND ADI MAKES NO WARRANTY. AS TO ITS USE OR PERFORMANCE. EXCEPT FOR ANY WARRANTY, CONDITION, REPRESENTATION OR TERM THE EXTENT TO WHICH CANNOT BE EXCLUDED OR LIMITED BY APPLICABLE LAW, ADI AND ITS SUPPLIERS MAKE NO WARRANTY, CONDITION, REPRESENTATION, OR TERM (EXPRESS OR IMPLIED, WHETHER BY STATUTE, COMMON LAW, CUSTOM, USAGE OR OTHERWISE) AS TO ANY MATTER INCLUDING, WITHOUT LIMITATION, NON INFRINGEMENT OF THIRD PARTY RIGHTS, MERCHANTABILITY, INTEGRATION, OR FITNESS FOR A PARTICULAR PURPOSE. YOU ASSUME RESPONSIBILITY FOR SELECTING THE SOLUTION TO ACHIEVE YOUR INTENDED RESULTS, AND FOR THE INSTALLATION OF, USE OF, AND RESULTS OBTAINED FROM THE EQUIPMENT AND SOFTWARE. WITHOUT LIMITING THE FOREGOING PROVISIONS, ADI MAKES NO WARRANTY THAT THE EQUIPMENT OR SOFTWARE WILL BE ERROR-FREE OR FREE FROM INTERRUPTIONS OR OTHER FAILURES OR THAT THE SOFTWARE OR EQUIPMENT WILL MEET YOUR REQUIREMENTS. UNDER NO CIRCUMSTANCES AND UNDER NO LEGAL THEORY, WHETHER IN TORT, CONTRACT, OR OTHERWISE, SHALL ADI OR ITS SUPPLIERS BE LIABLE TO PURCHASER OR TO ANY OTHER PERSON FOR LOSS OF PROFITS, LOSS OF GOODWILL, OR ANY INDIRECT, SPECIAL, INCIDENTAL, OR CONSEQUENTIAL DAMAGES, OR DAMAGES FOR GROSS NEGLIGENCE OF ANY CHARACTER INCLUDING, WITHOUT LIMITATION, DAMAGES FOR LOSS OF GOODWILL, WORK STOPPAGE, COMPUTER FAILURE OR MALFUNCTION, OR FOR ANY OTHER DAMAGE OR LOSS. IN NO EVENT SHALL ADI OR ITS SUPPLIERS BE LIABLE FOR ANY DAMAGES IN EXCESS OF THE PRICE PAID FOR THE EQUIPMENT AND SOFTWARE, EVEN IF ADI, OR ITS AUTHORIZED PARTNERS OR SUPPLIERS HAVE BEEN ADVISED OF THE POSSIBILITY OF SUCH DAMAGES.

ADI is acting on behalf of its suppliers for the purpose of disclaiming, excluding and/or limiting obligations, warranties and liability as provided in this agreement, but in no other respects and for no other purpose. The foregoing provisions shall be enforceable to the maximum extent permitted by applicable law.

### **Controlling Law and Severability**

This license shall be governed by the laws of the territory into which the software is sold, or if sold into the United States of America, by the laws of the State of California.

---

## Technical Support

The Purchaser is entitled to free technical support for any ADI product for one year from its date of purchase. Our technical support staff can provide advice concerning installation and operation of ADI products. Services outside of this may incur a charge. Technical support staff will not provide experimental protocols or procedural instructions for conducting experiments. However, information of this type may be provided in the supplied product documentation, or on ADI web sites.

## Inquiries

For additional information or service inquiries please contact the nearest ADInstruments office or Authorized Distributor. For contact details see [www.ADIInstruments.com](http://www.ADIInstruments.com)

Copyright © ADInstruments NZ Ltd, 2023. All rights reserved. PowerLab, LabChart and ADInstruments are registered trademarks of ADInstruments NZ Ltd. Windows 8, Windows 7, Windows 10, Windows Vista and .NET Framework are trademarks of Microsoft Corporation. Apple, the Apple logo, MacOS, and Macintosh are trademarks of Apple Computer Inc. registered in the U.S. and other countries. All other trademarks are the property of their respective owners.